

BP21MSSH Tech Sheet

Customer: Balboa Water Group

Part Number: 56381 800 Incoloy
56450 825 Incoloy
56451 Titanium

Custom Box Overlay

Box Overlay Part Number N/A

UL System Model: BP21-BP21MSSH-RCA3.0K

Software Version ID: M100_225 V12

Software Version: 12.0

File Name: BP2100_12.0_BP21MSSH_1.hex

Configuration Signature: B8B53035

Eng. Project Number: 3933

Base PCBA: 56382

Bare Board: 24082_E

Control Panels:

TP800 Software Version 2.9 and later

TP900 Software Version 2.9 and later

TP600 Software Version 2.6 and later

Auxiliary Panels

See Page 20



System Revision History

Part #	EPN	Date	Originator	Changes Made
56381	3933	01-03-13	BWG	Initial release - BP2100 with MicroSilk®
56450				
56451				

Manufactured under one or more of these patents. U.S. Patents: 5332944, 5361215, 5550753, 5559720, 5,883,459, 6253227, 6282370, 6590188, 6976052, 6965815, 7030343, 7,417,834 b2, Canadian Patent: 2342614, Australian patent: 2373248 other patents both foreign and domestic applied for and pending. © Copyright 2009 Balboa Water Group.



Basic Functions Setups 1-6

Power Requirements:

Single Service [3 wires (line, neutral, ground)]

230VAC, 50Hz, 1p, 32A, (Circuit Breaker rating = 40A max.)

Dual Service [5 wires (line 1, neutral 1, line 2, neutral 2, ground)] **NOT APPLICABLE WITH THIS SAMPLE**

230VAC, 50Hz, 1p, 2x 16A, (Circuit Breaker rating = 20A max each service.)

3-Service [5 wires (line 1, line 2, line 3, neutral, ground)]

400VAC, 50Hz, 3Np, 16A, (Circuit Breaker rating = 20A max each phase line.)

IMPORTANT - Service must include a neutral wire, with a line to neutral voltage of 230VAC.

System Outputs:

Pump 1 230VAC 2-Speed 12A max 15-minute timer for High Speed, 15-Minute timer for Low Speed

This is the heater pump in Setups 4-6

Must deliver 20 GPM through heater

Pump 2 230VAC 2-Speed 12A max 15-minute timer

in Setups 1 & 4

1-Speed 12A max 15-minute timer

in Setups 2 & 5

Pump 2 is not used in Setups 3 & 6

MicroSilk® 230VAC 1-Speed 12A max 30-minute timer

Circ Pump 230VAC* 1-Speed 2A max Programmable Filtration Cycles + Polling

This is the heater pump in Setups 1-3

Must deliver 20 GPM through heater

Ozone 230VAC* .5A max Slaved to Circ Pump in Setups 1-3, Independent in Setups 4-6

Spa Light 10VAC On/Off 1A max 240-minute timer.

A/V (Stereo) 230VAC Hot 5A max Always on

Heater 3.0kW @ 240VAC max

MicroSilk® is a registered trademark of Jason International

Hardware Setup

Wiring Diagram

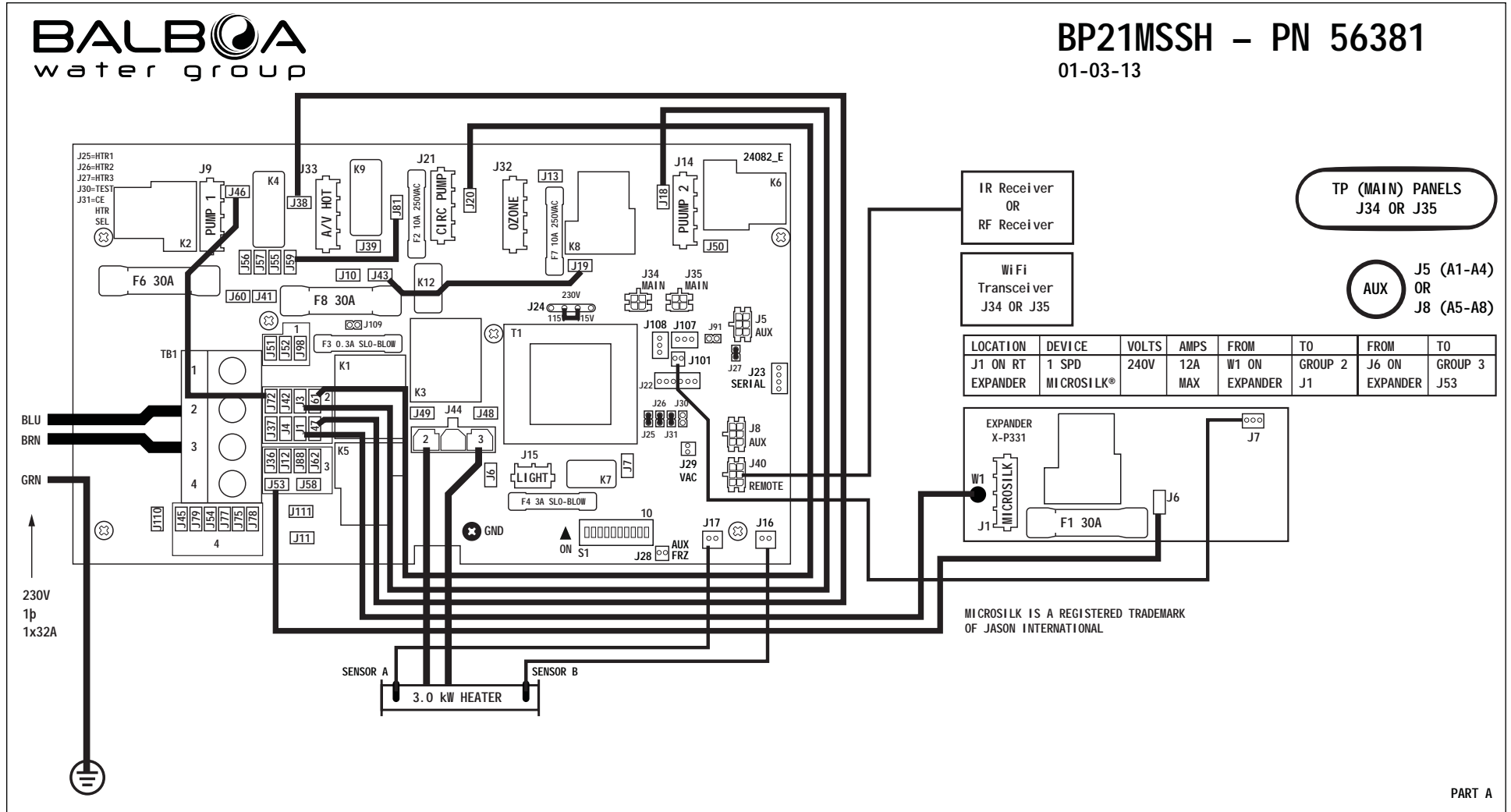

Manufactured under one or more of these patents. U.S. Patents: 5332944, 5361215, 5550753, 5559720, 5,883,459, 6253227, 6282370, 6590188, 6976052, 6965815, 7030343, 7,417,834 b2, Canadian Patent: 2342614, Australian patent: 2373248 other patents both foreign and domestic applied for and pending.

© Copyright 2009 Balboa Water Group.

BALBOA
water group

Hardware Setup

Settings

SINGLE SERVICE 230V 1p / 1x32A, THREE-SERVICE 230V 1p / 3x16A

LOCATION	DEVICE
J9	NETZSTROMVERSORGUNG 2-GESCHW.-PUMPE 1 ALIMENTATION POMPE 1 A 2 VITESSES 2-SPEED PUMP 1
J14	NETZSTROMVERSORGUNG 2-GESCHW.-PUMPE 2 ALIMENTATION POMPE 2 A 2 VITESSES 2-SPEED PUMP 2
	PUMP 2 LINE 1 CONNECTION J19 to J57
J15	10V BELEUCHTUNG ECLAIRAGE BAIN HYDRO SPA LIGHT
J21	KREISLAUF PUMPE POMPE DE CIRCULATION CIRC PUMP
J32	OZONGENERATOR GENERATOROZONE OZONE GENERATOR
	CIRC AND OZONE LINE 1 CONNECTION J81 to J55
J33	TV / AV
J40	IR RECIEVER
J5, J8	AUX PANEL(S) - AX10, AX20, AX30, AX40

PUMP 2 IS 2-SPEED IN SETUPS 1 & 4
 PUMP 2 IS 1-SPEED IN SETUPS 2 & 5
 PUMP 2 IS NOT USED IN SETUPS 3 & 6

SETUP #	CIRC PUMP	PUMP 1	PUMP 2	MicroSiIk®	TEMP SCALE
1	PROGRAMMABLE FILTRATION + POLLING	2-SPEED	2-SPEED	1-SPEED	°C
2	PROGRAMMABLE FILTRATION + POLLING	2-SPEED	1-SPEED	1-SPEED	°C
3	PROGRAMMABLE FILTRATION + POLLING	2-SPEED	NONE	1-SPEED	°C
4	NONE	2-SPEED	2-SPEED	1-SPEED	°C
5	NONE	2-SPEED	1-SPEED	1-SPEED	°C
6	NONE	2-SPEED	NONE	1-SPEED	°C

PUMP 1 LOW TIMEOUT IS 15 MINUTES.

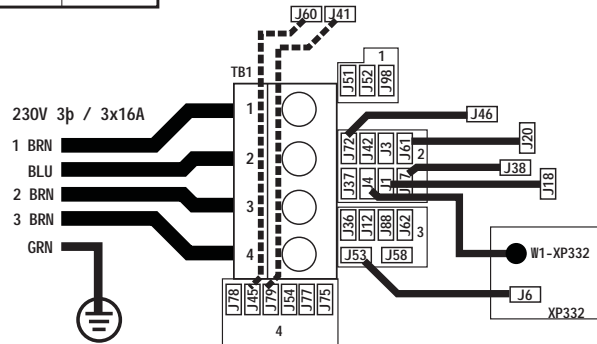

FOR SUPPLY CONNECTIONS,
 USE CONDUCTORS SIZED ON THE
 BASIS OF 60°C AMPACITY BUT
 RATED MINIMUM OF 90°C.

USE COPPER CONDUCTORS ONLY.
 EMPLOYER UNIQUEMENT
 DES CONDUCTEURS DE CUIVRE.

TORQUE RANGE FOR
 MAIN TERMINAL BLOCK (TB1):
 27-30 IN. LBS.
 (31.1-34.5 kg cm)

BALBOA
 water group

SWITCHBANK S1 OFF

TEST MODE OFF	SWITCH	TEST MODE ON
DON'T ADD 1 HS PUMP W/HTR	◀ A1	ADD 1 HS PUMP WITH HEAT
DON'T ADD 2 HS PUMPS W/HTR	◀ A2	ADD 2 HS PUMPS WITH HEAT
DON'T ADD 4 HS PUMPS W/HTR	◀ A3	ADD 4 HS PUMPS WITH HEAT
SPECIAL AMPERAGE RULE A*	◀ A4	SPECIAL AMPERAGE RULE B*
STORE SETTINGS**	◀ A5	MEMORY RESET**
NOT ASSIGNED	◀ A6	NOT ASSIGNED
NOT ASSIGNED	◀ A7	NOT ASSIGNED
NOT ASSIGNED	◀ A8	NOT ASSIGNED
NOT ASSIGNED	◀ A9	NOT ASSIGNED
NOT ASSIGNED	◀ A10	NOT ASSIGNED

**SWITCH # 6 SHOULD BE SET TO OFF UPON FINAL INSTALLATION.

SWITCHBANK S1 OFF

TEST MODE OFF	SWITCH	TEST MODE ON
DON'T ADD 1 HS PUMP W/HTR	◀ A1	ADD 1 HS PUMP WITH HEAT
DON'T ADD 2 HS PUMPS W/HTR	◀ A2	ADD 2 HS PUMPS WITH HEAT
DON'T ADD 4 HS PUMPS W/HTR	◀ A3	ADD 4 HS PUMPS WITH HEAT
SPECIAL AMPERAGE RULE A*	◀ A4	SPECIAL AMPERAGE RULE B*
STORE SETTINGS**	◀ A5	MEMORY RESET**
NOT ASSIGNED	◀ A6	NOT ASSIGNED
NOT ASSIGNED	◀ A7	NOT ASSIGNED
NOT ASSIGNED	◀ A8	NOT ASSIGNED
NOT ASSIGNED	◀ A9	NOT ASSIGNED
NOT ASSIGNED	◀ A10	NOT ASSIGNED

**SWITCH # 6 SHOULD BE SET TO OFF UPON FINAL INSTALLATION.

INSTEAD OF SETUP #1,
 THIS SYSTEM IS CONFIGURED IN SETUP #:

SYSTEM WILL BE IN SETUP #1
 UNLESS MARKED OTHERWISE →

BP21MSSH - PN 56381
 01-03-13

PART B

Setup Reference Table

Setup #	Circ Pump	Pump 1	Pump 2	MicroSilk®		Temp Scale
1	Programmable Filtration + Polling	2-Speed	2-Speed	1-Speed		°C
2	Programmable Filtration + Polling	2-Speed	1-Speed	1-Speed		°C
3	Programmable Filtration + Polling	2-Speed	None	1-Speed		°C
4	None	2-Speed	2-Speed	1-Speed		°C
5	None	2-Speed	1-Speed	1-Speed		°C
6	None	2-Speed	None	1-Speed		°C

System is shipped in Setup 1

Pump 1 Low timeout is 15 minutes.

Changing Software Setups

Test Menu Access (S1, Switch 1 ON) *Service Technician ONLY.*

DANGER! HIGH VOLTAGE WILL BE ACCESSIBLE! SERVICE TECHNICIAN ONLY!

While the system is running, move DIP Switch 1 (on S1 on the Main circuit board) to ON. The system will enter Test Mode. Moving DIP Switch 1 to OFF will exit Test Mode.

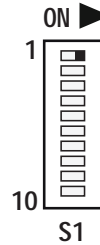

Software Setups

Under the TEST Menu, the Setup screen will allow changing the Setup from 1 to any number established by the Manufacturer. Changing the Setup may require wiring changes as well.

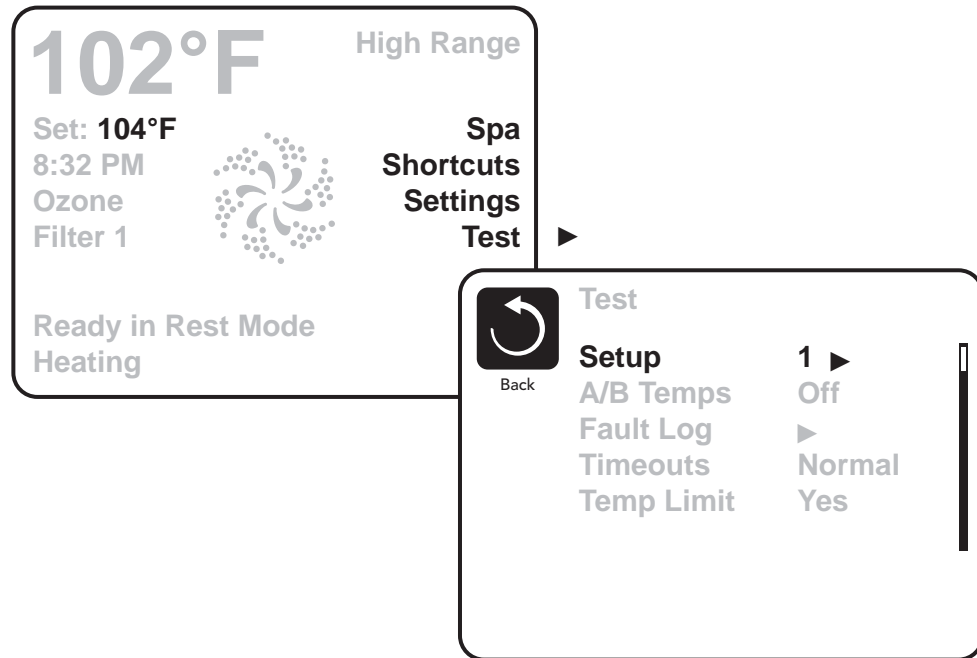

Equipment Expansion

Expansion Features

Control Connection

	Default	Fuse
Relay 1 (J101)	MicroSilk®	30A
Relay 7/8 (J107)	Undefined	None
Relay 9/10 (J108)	Undefined	None

DIP Switch Functions

Fixed-function DIP Switches

- A1 Test Mode (normally Off).
- A2 In "ON" position, add one high-speed pump (or blower) with Heater.
- A3 In "ON" position, add two high-speed pumps (or 1 HS Pump and Blower) with Heater.
- A4 In "ON" position, add four high-speed pumps (or 3 HS Pumps and Blower) with Heater.
- A5 In "ON" position, enables Special Amperage Rule B. See Special Features section under Configuration Options for functionality with your system.
In "OFF" position, enables Special Amperage Rule A.
- A6 Persistent memory reset (Used when the spa is powering up to restore factory settings as determined by software configuration).

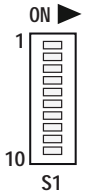







A2, A3, and A4 work in combination to determine the number of high-speed devices and blowers that can run before the heat is disabled. i.e. A2 and A3 in the ON position and A4 in the OFF position will allow the heater to operate with up to 3 high-speed pumps (or two HS Pumps and Blower) running at the same time. Heat is disabled when the fourth high-speed pump or blower is turned on.

Note: A2/A3/A4 all off = No heat with any high-speed pump or blower.

Undesignated switches are not assigned a function.

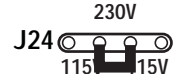
Jumper Definitions

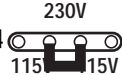
J109	GFCI Test/Trip Enable. NOT APPLICABLE IN CE SYSTEMS	J109 
	Note: This feature must be enabled in software as well.	
J91	Real Time Clock Enable/Disable	J91 
	Note: This Jumper should NOT be shorted when the Control Panel can display time of day.	
J30	Do Not Use	
J31	Jumper on 1 pin with 2.0kW or smaller heater Jumper on 2 pins with a 3.0kW or higher heater	J31 
J29	Do Not Use	J29 
J25, J26, J27	Heater Type Settings. Note: Factory Configured do not change.	J25  J26  J27 
J24	Jumper on center two pins (230V) when heater is running at 240V. Two Jumpers installed; one on left 2 pins and one on right 2 pins (115V) when heater is running at 120V.	J24 

Warning!

Setting DIP switches or jumpers incorrectly may cause abnormal system behavior and/or damage to system components. Refer to Switchbank illustration on Wiring Configuration page for correct settings for this system. Contact Balboa if you require additional configuration pages added to this tech sheet.

BP2100 Configuration Options

General Features

Feature	Default
Pump 1 in Filter Cycle (Circ Only)	No
Pump 1 Low Timer	<i>15 Minutes</i>
General Pump Timer	15 Minutes
Blower Timer	30 Minutes
MicroSilk® Timer	30 Minutes
Mister Timer	15 Minutes
Light Timer	240 Minutes
Circ (when enabled)	Programmable + Polling
Cleanup Cycle	<i>30 Minutes</i>
Cleanup as Preference setting	<i>Yes</i>
Ozone	With Heater Pump*
Ozone Suppression	OFF
Pump Purge	60 Seconds
Blower Purge	30 Seconds
Mister Purge	5 Seconds

* The heater Pump can be either a Circ Pump or Pump 1 Low.

Blue Indicates New Custom Configuration Default (Setup 1)

Manufactured under one or more of these patents. U.S. Patents: 5332944, 5361215, 5550753, 5559720, 5,883,459, 6253227, 6282370, 6590188, 6976052, 6965815, 7030343, 7,417,834 b2, Canadian Patent: 2342614, Australian patent: 2373248 other patents both foreign and domestic applied for and pending. © Copyright 2009 Balboa Water Group.

BP2100 Configuration Options

Temperature Features

Feature	Default
Temperature Display	°C

All temperatures must be specified in °F. The system converts °F to °C dynamically. If Celsius is required for default settings, choose a desired °C value that (after rounding) corresponds to a Fahrenheit value.

°C	4	5	6	7	8	9	10	11	12	13	14	15	16	17	18	19	20	21	22
°F	39	41	43	45	46	48	50	52	54	55	57	59	61	63	64	66	68	70	72
°C	23	24	25	26	27	28	29	30	31	32	33	34	35	36	37	38	39	40	
°F	73	75	77	79	81	82	84	86	88	90	91	93	95	97	99	100	102	104	

Hi-Range Min. Set Temp	80°F
Hi-Range Max. Set Temp	104°F
Hi-Range Default Temp*	100°F
Lo-Range Min. Set Temp	50°F
Lo-Range Max. Set Temp	99°F
Lo-Range Default Temp*	70°F
Freeze Threshold	44°F
Temp Lock Type	Temp + Settings

*May be changed by end-user (if enabled)

Blue Indicates New Custom Configuration Default (Setup 1)

Manufactured under one or more of these patents. U.S. Patents: 5332944, 5361215, 5550753, 5559720, 5,883,459, 6253227, 6282370, 6590188, 6976052, 6965815, 7030343, 7,417,834 b2, Canadian Patent: 2342614, Australian patent: 2373248 other patents both foreign and domestic applied for and pending. © Copyright 2009 Balboa Water Group.



BP2100 Configuration Options

Time Features

Feature	Default
Time Format*	24 Hour
Filter 1 Start Hour*	20:00 (8:00 PM)
Filter 1 Duration*	2 Hours
Filter Cycle 2 Default*	OFF
Filter 2 Start Hour*	08:00 (8:00 AM)
Filter 2 Duration*	15 Minutes
Light Cycle	Disabled
Light Cycle Default*	OFF
Light Cycle Start Hour*	21:00 (9:00 PM)
Light Cycle Duration*	15 Minutes

**May be changed by end-user (if enabled)*

Blue Indicates New Custom Configuration Default (Setup 1)

Manufactured under one or more of these patents. U.S. Patents: 5332944, 5361215, 5550753, 5559720, 5,883,459, 6253227, 6282370, 6590188, 6976052, 6965815, 7030343, 7,417,834 b2, Canadian Patent: 2342614, Australian patent: 2373248 other patents both foreign and domestic applied for and pending. © Copyright 2009 Balboa Water Group.

BP2100 Configuration Options

Reminder Features

Feature	Default
Reminders Shown*	<i>Yes</i>
Check pH	<i>OFF</i>
Check Sanitizer	<i>OFF</i>
Clean Filter	30 Days
Test GFCI	<i>65 Days</i>
Drain Water	<i>100 Days</i>
Change Cartridge	OFF
Clean Cover	<i>OFF</i>
Treat Wood	<i>OFF</i>
Change Filter	365 Days

**May be changed by end-user (if enabled)*

Blue Indicates New Custom Configuration Default (Setup 1)

Manufactured under one or more of these patents. U.S. Patents: 5332944, 5361215, 5550753, 5559720, 5,883,459, 6253227, 6282370, 6590188, 6976052, 6965815, 7030343, 7,417,834 b2, Canadian Patent: 2342614, Australian patent: 2373248 other patents both foreign and domestic applied for and pending. © Copyright 2009 Balboa Water Group.

BP2100 Configuration Options

Special Features

Feature

Default

Special Amperage Rule A

No Limitation

Special Amperage Rule B

No Limitation

Drain Mode

Disabled

Demo Mode

Disabled

Automatic GFCI Test

Disabled

Ozone Slaved to Heater Pump

Yes in Setups 1-3

No in Setups 4-6

Dual Voltage Heater

Always Input Voltage

Safety Suction

Disabled

TP600 Panel Configuration

Button Layout Table

Feature #	2 Pumps Setups 1, 2, 4 & 5	1 Pump Setups 3 & 6
A1	Jets 1	Jets 1
A2	Jets 2	Undefined
A3	MicroSilk®	MicroSilk®
A4	Up	Up
A5	Light 1	Light 1
A6	Down	Down
B1	Jets 1	Jets 1
B2	Jets 2	Undefined
B3	Light 1	Light 1
B4	Heat On	Heat On



TP600

50015-XX

(no overlay - International)

TP800 Panel Configuration

Button Layout Table

Feature #	2 Pumps & Circ Setups 1 & 2	1 Pump & Circ Setup 3	2 Pumps & NO Circ Setups 4 & 5	1 Pumps & NO Circ Setup 6
A1	N/A	N/A	N/A	N/A
A2	Jets 1	Jets 1	Jets 1	Jets 1
A3	Jets 2	MicroSilk®	Jets 2	MicroSilk®
A4	MicroSilk®	Light 1	MicroSilk®	Light 1
A5	Light 1	Invert	Light 1	Invert
A6	Invert	(Circ Icon)	Invert	Undefined
A7	(Circ Icon)	Undefined	Undefined	Undefined
A8	Undefined	Undefined	Undefined	Undefined
A9	Undefined	Undefined	Undefined	Undefined
A10	Undefined	Undefined	Undefined	Undefined
A11	N/A	N/A	N/A	N/A
A12	N/A	N/A	N/A	N/A
A13	Undefined	Undefined	Undefined	Undefined
A14	Undefined	Undefined	Undefined	Undefined
A15	Undefined	Undefined	Undefined	Undefined
A16	Undefined	Undefined	Undefined	Undefined
B1	Jets 1	Jets 1	Jets 1	Jets 1
B2	Jets 2	Undefined	Jets 2	Undefined
B3	MicroSilk®	MicroSilk®	MicroSilk®	MicroSilk®
B4	Light 1	Light 1	Light 1	Light 1

TP800 Panel Configuration

Spa Screen

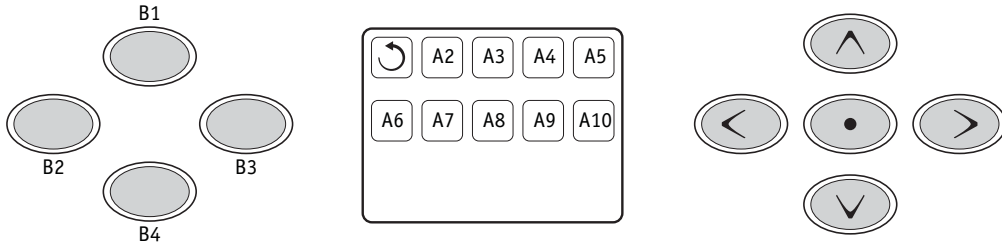

Shortcuts Screen

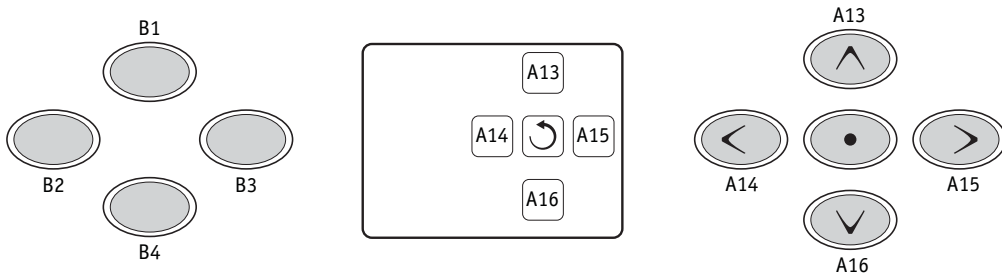

Note: Buttons 11 and 12 are not used in this configuration.

Button 1 is fixed.

Panel Part Number _____

Overlay Part Number _____

A Circ Icon will appear when a Circ Pump is configured using Setups 3, 4, 8, 9

TP900 Panel Configuration

Button Layout Table

Button #	2 Pumps & Circ Setups 1 & 2	1 Pump & Circ Setup 3	2 Pumps & NO Circ Setups 4 & 5	1 Pumps & NO Circ Setup 6
1	N/A	N/A	N/A	N/A
2	Jets 1	Jets 1	Jets 1	Jets 1
3	Jets 2	MicroSilk®	Jets 2	MicroSilk®
4	MicroSilk®	Light 1	MicroSilk®	Light 1
5	Light 1	Invert	Light 1	Invert
6	Invert	(Circ Icon)	Invert	Undefined
7	(Circ Icon)	Undefined	Undefined	Undefined
8	Undefined	Undefined	Undefined	Undefined
9	Undefined	Undefined	Undefined	Undefined
10	Undefined	Undefined	Undefined	Undefined
11	N/A	N/A	N/A	N/A
12	N/A	N/A	N/A	N/A
13	Jets 1	Jets 1	Jets 1	Jets 1
14	Jets 2	Undefined	Jets 2	Undefined
15	MicroSilk®	MicroSilk®	MicroSilk®	MicroSilk®
16	Light 1	Light 1	Light 1	Light 1

Spa Screen

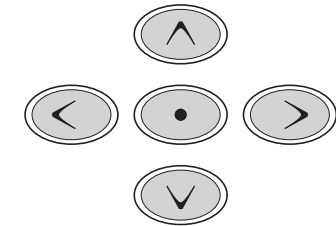
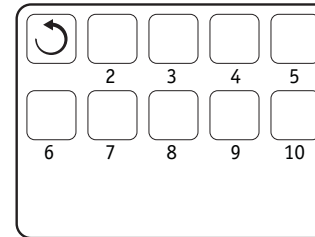

Shortcuts Screen

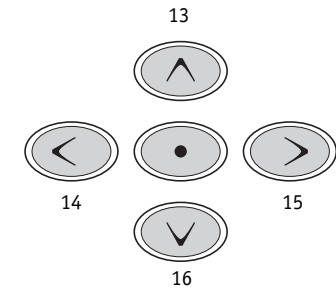
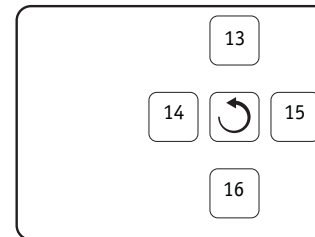

A Circ Icon will appear when a Circ Pump is configured.

BP2100 Configuration Options

Auxilliary Panel Features on Bank 1*

Feature	Default
Aux Button A1	Jets 1
Aux Button A2	Jets 2
Aux Button A3	MicroSilk®
Aux Button A4	Light

Auxilliary Panel Features on Bank 2*

Feature	Default
Aux Button A5	Jets 1
Aux Button A6	Jets 2
Aux Button A7	MicroSilk®
Aux Button A8	Light

*Bank 1 consists of J5 on the Main Circuit Board.

Bank 2 consists of J8 on the Main Circuit Board.

Aux Connection Splitter PN25257 may be required.

BP2100 Configuration Options

Auxilliary Panel Features

AX10 Panels on Bank 1*

A1, AX10A1	No O/L	52803
A2, AX10A2	No O/L	52804
A3, AX10A3	No O/L	55805 Controls MicroSilk®
A4, AX10A4	No O/L	52806

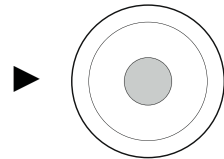

Call Customer Service for additional information about Auxiliary Panels.

Auxiliary Panel Part Number _____

Overlay Part Number _____

AX10 Panels on Bank 2*

A5, AX10A1	No O/L	52803
A6, AX10A2	No O/L	52804
A7, AX10A3	No O/L	52805 Controls MicroSilk®
A8, AX10A4	No O/L	52806

*Bank 1 consists of J5 on the Main Circuit Board.

Bank 2 consists of J8 on the Main Circuit Board.

Aux Connection Splitter PN25257 may be required.

AX20

AX20 A1A2	No O/L	52800
AX20 A1A3	No O/L	52801
AX20 A1A4	No O/L	52802

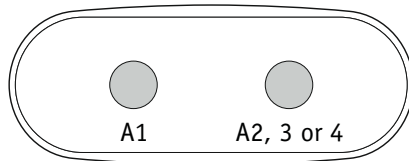

AX20 Auxiliary Panel plugged into Bank 1 will operate A1 + A2, A3 or A4.

AX20 Auxiliary Panel plugged into Bank 2 will operate A5 + A6, A7 or A8.

AX40

AX40	No O/L	52799
------	--------	-------

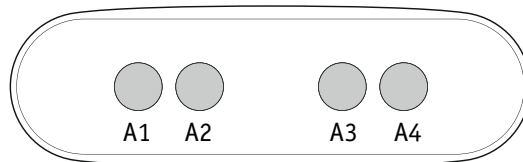

AX40 Auxiliary Panel plugged into Bank 1 will operate A1 + A2, A3 and A4.

AX40 Auxiliary Panel plugged into Bank 2 will operate A5 + A6, A7 and A8.

BP2100 Configuration Options

Remote Panel Features

Feature	Default
Remote Button A1	Jets 1
Remote Button A2	Jets 2
Remote Button A3	MicroSilk®
Remote Button A4	Undefined
Remote Button A5	Light
Remote Button A6	Undefined
Remote Button A7	Undefined
Remote Button A8	Undefined

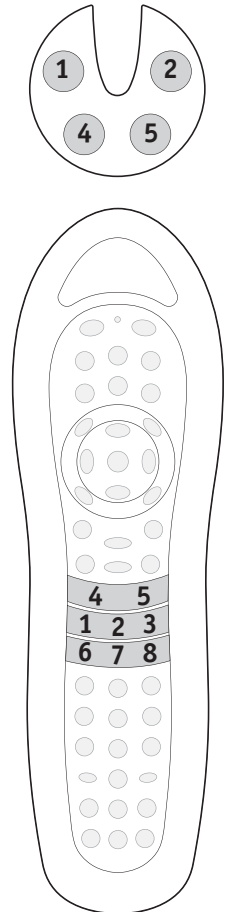

Remote Panel Part Number _____
 Overlay Part Number _____