

EL1001 Mach 3 Tech Sheet

Balboa Instruments System PN 54388-04

System Model # E1P-EL1001M3-DCAH

Software Version # 32

EPN # 2833

Base PCBA – PN 54389-04

PCB EL1000 – PN 22952 Rev B or C

HEX File – 10010432

Base Panels

ML400 – PN 52684



System Revision History

System PN	EPN	Date	Requested By	Changes Made
54388-02	2130	11.16.2006	Balboa	Software update to v28
54388-03	n/a	07.20.2007	Balboa	Software update to v30
54388-04	2833	04.30.2008	Balboa	Software update to v32

Basic System Features and Functions

Power Requirements

- 240VAC, 60Hz, 40A, Class A GFCI-protected service (Circuit Breaker rating = 50A max.)
- 4 wires (hot, hot, neutral, ground)

System Outputs

Setup 1 (As Manufactured)

- 240V Pump 1, 2-Speed
- 240V Blower, 1-Speed
- 120V Ozone
- 12V Spa Light
- 240V 5.5kW Heater *

* Heater wattage is rated at 240V. When running 120V to heater, output is approximately 25%.

Additional Options

- Full Feature Dolphin Remote and Spa-only Dolphin Remote
- Spa Monitor
Connects to Main Panel terminal J70 or J71
- IR or RF Dolphin Receiver Module
Connects to Remote terminal J20
- Ozone Generator
Connects to terminal J9
- MoodEFX Lighting
Connects to Spa Light terminal J12
- FiberEFX Lighting
Connects to Spa Light terminal J12
- Stereo System
Connects to A.V. terminal J2

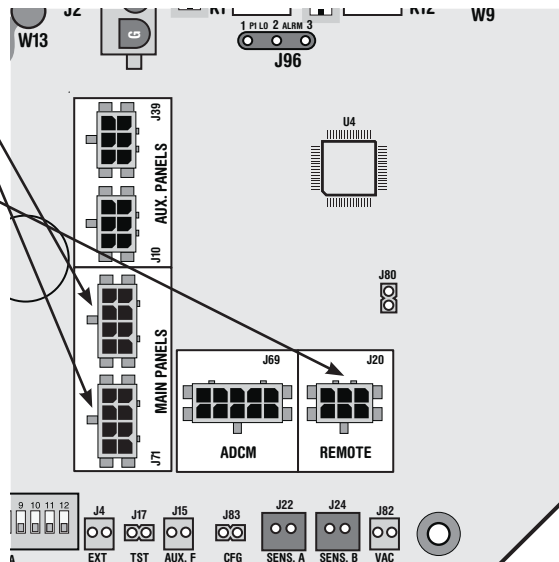

Persistent Memory and Powering Up

Any time you change DIP Switches or Software Configuration Settings that affect parameters the user can change (any filter settings, set temperature default, Celsius vs Fahrenheit, 12-hour vs 24-hour time, reminders suppression, etc), you must reset Persistent Memory for your DIP Switch or Software Configuration Settings changes to take effect. You should also reset Persistent Memory after loading a new file into a board (using the ESM, purchased separately).

To reset Persistent Memory:

- Power down.
- Set A12 ON (See illustration below).
- Power up.
- Wait until “P” or “PRIMING MODE” is displayed on your panel.
Note: If “CFE” appears see section below.
- Set A12 OFF. (This can be done safely with power on if you use a non-conductive tool such as a pencil to push the switch back to the OFF position. Otherwise, power down before setting A12 OFF)
- Power up again (if you powered down in the previous step).
- For all other power ups, leave A12 OFF

About Persistent Memory and Time of Day Retention:

This system uses memory that doesn't require a battery to store a variety of settings. What we refer to as Persistent Memory stores all the User Preferences, as well as all the filter settings, the set temperature, and the heat mode.

Persistent Memory is not used for Time of Day. Time of Day needs to be “kept running” (not just stored) while the power is off, so a separate Real Time Clock feature (on all models except the EL1000) keeps track of Time of Day while the unit is off. Time of Day Retention, and Time of Day Retention alone, is controlled by the J91 jumper. J91 must be set according to main system panel used.

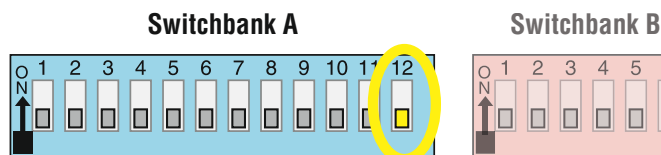

CFE message on power up:

If “CFE” appears before (and instead of) “P” or “PRIMING MODE”, you have not configured DIP Switches and/or Software Configuration Settings in a valid manner. This must be corrected before you can reset Persistent Memory.

The switch numbers, jumpers, or configuration settings displayed after “CFE” are ones with which the system has found a configuration problem.

For example:

- “CFE A5 B2” would mean that the combination of how you've set A5 and how you've set B2 is not supported on this system.
- “CFE J99” would mean that there is a problem with jumper J99
- “CFE P3 1 BL 1” would mean that the combination of how you've set pump 3 for 1-speed and blower for 1-speed is not supported on this system.
- “CFE P3_ BL_” would mean that the combination of how you've set DIP switches which have been assigned to pump 3 and blower is not supported on this system.

Power Up Display Sequence

Upon power up, you should see the following on the display:

- Three numbers in a row, which are the SSID (the System Software ID). The third display of these numbers is the Software Version, which should match the version of your system. For example, if these three numbers are 100 134 26, that is a Mach 3 EL8000 at version 26.
- If there is a Configuration Error, the CFE message (see above) will appear at this point (and none of the messages below will display). Otherwise what comes next is:
- An indication of either the input voltage detected (EL1000/EL2000), or the heater wattage range supported (EL8000/GL2000/GL8000).
 - Heater wattage display: “1-3” means the system supports a heater from 1 kW to 3 kW. “3-6” means the system supports a heater from 3 kW to 6 kW. “3-3” means the system supports a 3 kW heater only. (These ranges may be modified slightly in the case of special heaters, which the next bullet covers.)
 - Input voltage display: A system showing “240” supports 3 kW to 6 kW heaters. A system showing “120” supports the very same heaters, although at 120V those heaters will function at only 1/4 of their 240V rated wattage. (The system shows only either “240” or “120” as a general indication of input voltage; it does not show the actual input voltage.)
- If your system is using a special type of heater, a display such as “H B” may appear next. If your system is using the generic Balboa heater, no heater type display will appear.
- “P” or “PRIMING MODE” will appear to signal the start of Priming Mode.

At this point, the power up sequence is complete. Refer to the User Guide for the ML Series panel on your system for information about how the spa operates from this point on.

Wiring Configuration and DIP Settings

Setup 1 (As Manufactured)

- 240V Pump 1, 2-Speed
- 240V Blower, 1-Speed
- 12V Spa Light
- 120V Ozone
- 240V 5.5kW Heater
- ML400 Main Panel

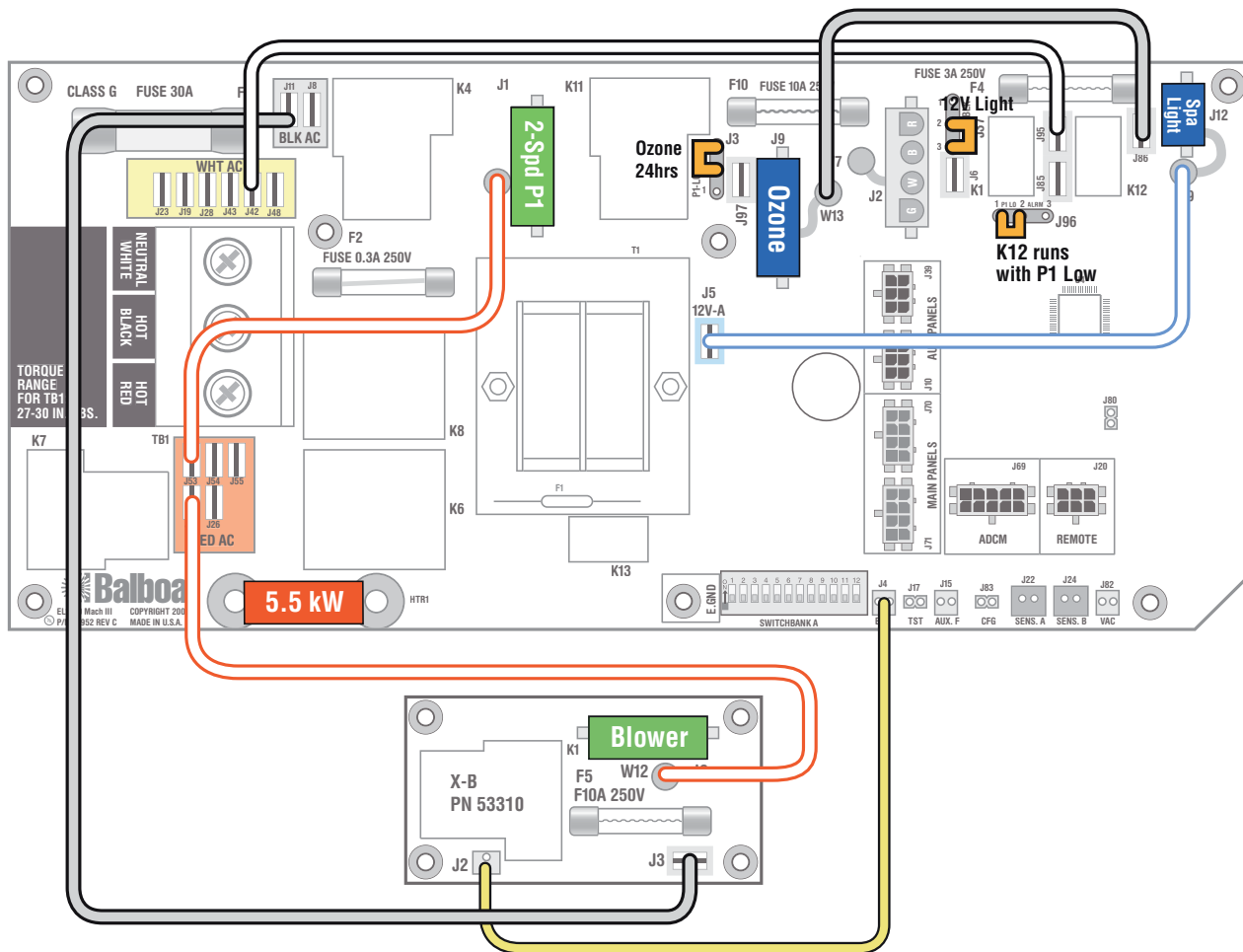

WARNING: Main Power to system should be turned OFF BEFORE adjusting DIP switches.
WARNING: Persistent Memory (A12) must be RESET to allow new DIP switch settings to take effect. (See Persistent Memory page)

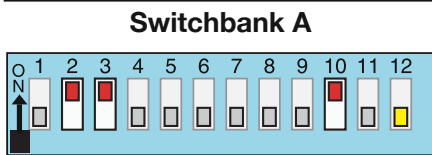
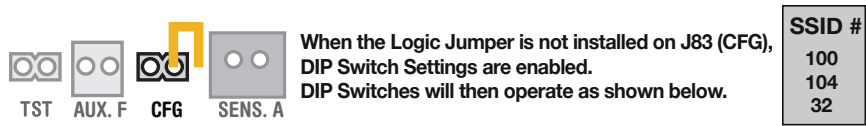

- A1, Test Mode OFF
- A2, High Amp
- A3, Filter by Duration
- A4, 12 Hr Time
- A5, Degrees F
- A6, Short Timeouts
- A7, Cleanup Cycles OFF
- A8, Pump 2 Disabled
- A9, No Circ Pump
- A10, Blower Enabled (A8 Off)
- A11, Do Not Use
- A12, Memory ON**

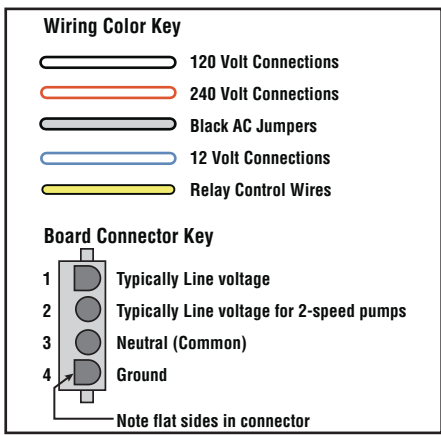
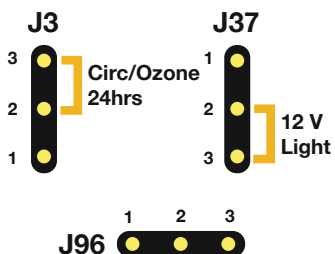

DIP Switches and Jumpers Definitions

WARNING:

- Setting DIP switches incorrectly may cause abnormal system behavior and/or damage to system components.
- Refer to Switchbank illustration on Wiring Configuration page for correct settings for this system.
- Contact Balboa if you require additional configuration pages added to this tech sheet.

DIP Switchbank A Key

- A 1 Test Mode (normally Off)
- A 2 In "ON" position, heater can run while any/all high-speed pumps or blowers are running. (High amperage)
..... In "OFF" position, heater is disabled while any high-speed pump or blower is running. (Low amperage)
- A 3 In "ON" position, filter cycles are programmed by duration
..... In "OFF" position, filter cycles are programmed to start and end times
- A 4 In "ON" position, displays time in 24 hours (military time)
..... In "OFF" position, displays 12 hour time
- A 5 In "ON" position, displays temperature in Celsius
..... In "OFF" position, displays temperature in Fahrenheit
- A 6 In "ON" position, Equipment timeout 30 minutes (4 hours for Pump 1 Low)
..... In "OFF" position, Equipment timeout 15 minutes (2 hours for Pump 1 Low)
- A 7 In "ON" position, Cleanup Cycle – 30 minutes after spa use/timeout, Pump 1 Low & Ozone run for 1 hour.
..... In "OFF" position, no Cleanup Cycle
- A 8 In "ON" position, enables Pump 2 (A10 must be Off)
..... In "OFF" position, disables Pump 2
- A 9 In "ON" position, Circ Pump 24 Hours with 3°F Shut-off. *See note below.
..... In "OFF" position, no Circ Pump
- A 10 In "ON" position, Blower enable when Pump 2 is disabled (A8 must be Off)
..... In "OFF" position, Blower disabled
- A 11 In "ON" position, DO NOT USE. *See note below.
..... In "OFF" position, Pump 1 is two-speed
- A 12 Persistent memory reset (normally off) (used when spa is powering up)

*Note: For systems with a Circ Pump, software must be v30 or higher and requires X-03 expansion board to be installed. Also, the Ozone generator, if installed, will be moved to X-03 board.

Jumpers

- J3** Jumper on Pins 1 and 2 will power J9 (Ozone) with Pump 1 Low.
Jumper on Pins 2 and 3 will power J9 to run 24 hours.
- J37** Jumper on Pins 1 and 2 will power one leg of J12 (Spa Light) at 120 Volts AC.
Jumper on Pins 2 and 3 will power one leg of J12 (Spa Light) at 12 Volts AC.
Note: W9 controls voltage on the other leg of J12 and must be set for the same voltage.
- J96** Jumper on Pins 1 and 2 will operate the relay K12 with Pump 1 Low.
Jumper on Pins 2 and 3 will operate the relay K12 independently.

Ozone Connections

Ozone Connector Voltage: The EL circuit board is factory configured to deliver a preset voltage (120V or 240V) to the on-board ozone connector (J9). See the ratings table on the wiring diagram attached to the cover of the enclosure for the configured voltage. For 240V output W13 connects to Red AC and for 120V output W13 connects to White AC.

The voltage to the ozone connector can be changed in the field if required. W13 just needs to be set for the required voltage.

Balboa Ozone Generator: If the board is set up to operate a 120V ozone generator, the connector on the ozone generator is likely to be configured correctly, but should be compared to the illustration below.

If a 240V ozone generator is required, be sure the red wire in the ozone cord is positioned in the connector next to the green ground wire as described below.

Note: A special tool is required to remove the pins from the connector body once they are snapped in place. Check with your Balboa Account Manager for information on purchasing a pin-removal tool.

Balboa Ozone connector configuration for 120V 60Hz

- Line - Black conductor
- Use this slot for the leftover Red conductor
- Common - Install the White conductor here for 120V ozone
- Ground (Green) conductor

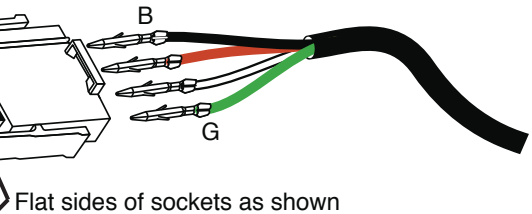

Balboa Ozone connector configuration for 240V 60Hz

- Line - Black conductor
- Use this slot for the leftover White conductor
- Common - Install the Red conductor here for 240V ozone
- Ground (Green) conductor

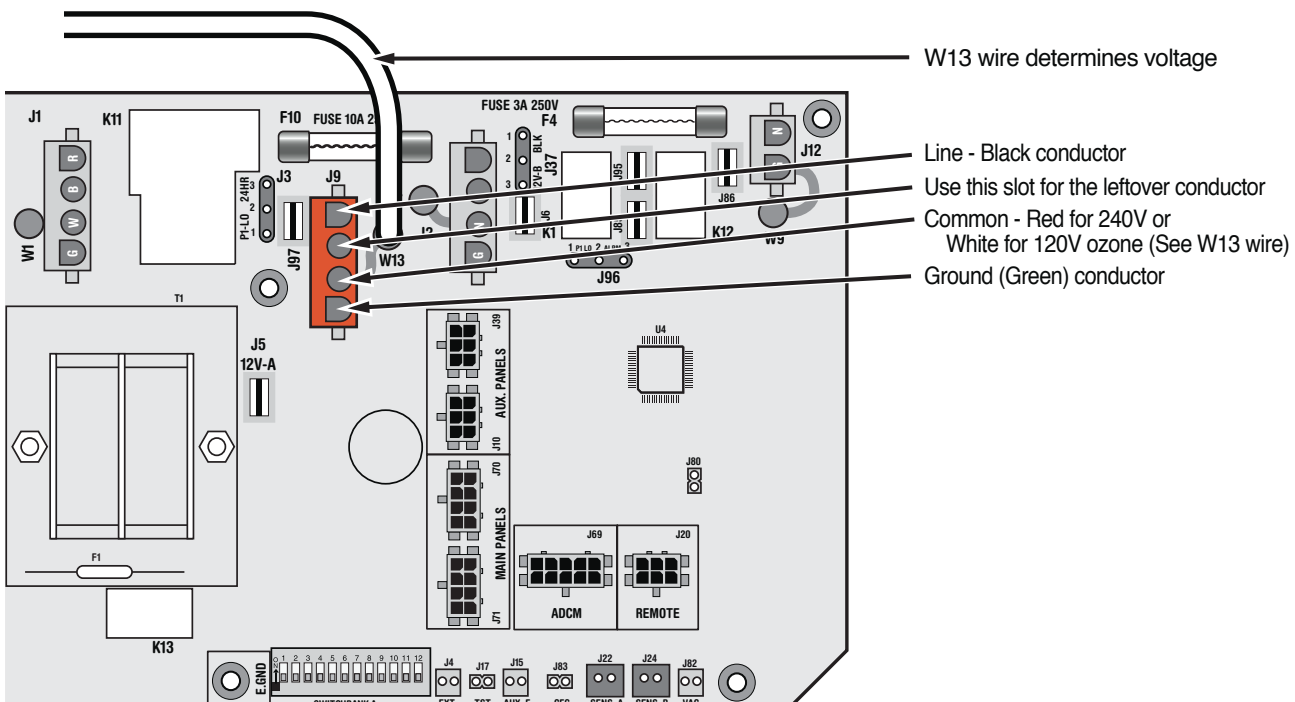
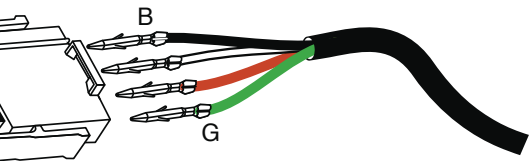

Panel Configurations

NON-TIME CAPABLE

Note: Connects to Main Panel terminal J70 or J71



ML400
PN 52684 with Overlay PN 11345