

# Introducing the EL2000 Mach 3

## Eval Kit - Option 3 Balboa Instruments

System Model # EL2-EL2000-YCAH  
Software Version # 21

Base PCBA PN  
EL2000 – 54272 (PCB 22896 Rev A)

Base Panels  
ML 700 – PN 52649



# Basic System Features and Functions

## Power Requirements

- 240VAC, 50/60Hz, 50A, GFCI-protected service
- 4 wires (hot, hot, neutral, ground)

## System Outputs (As Configured)

- 240V Pump 1, 2-Speed (high speed: 15-minute timeout; low-speed; 2-hour timeout)
- 240V Pump 2, 1-Speed (15-minute timeout; 1-minute for purge cycle w/filter)
- 240V Pump 3, 1-Speed (15-minute timeout; 1-minute for purge cycle w/filter)
- 120V Ozone (ozone runs with pump 1 low)
- 12V Spa Light (4-hour timeout)
- 120V AV (Stereo)
- 240V 5.5kw Heater

## Additional Options

- Full Feature Dolphin Remote and Spa-only Dolphin Remote



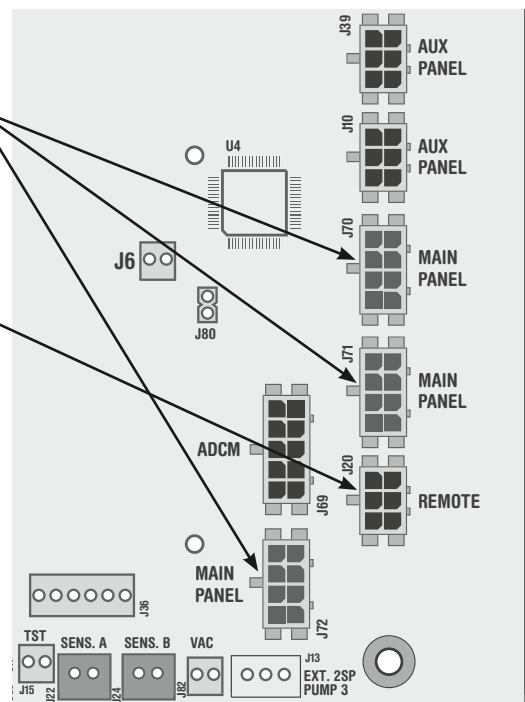

- Spa Monitor  
Connects to Main Panel terminal J70 or J71 or J72
- RF Dolphin Receiver Module  
Connects to Remote terminal J20
- Ozone Generator  
Connects to terminal J9
- MoodEFX Lighting  
Connects to Spa Light terminal J12
- FiberEFX Lighting  
Connects to Spa Light terminal J12
- JBL Stereo System  
Connects to A.V. terminal J4

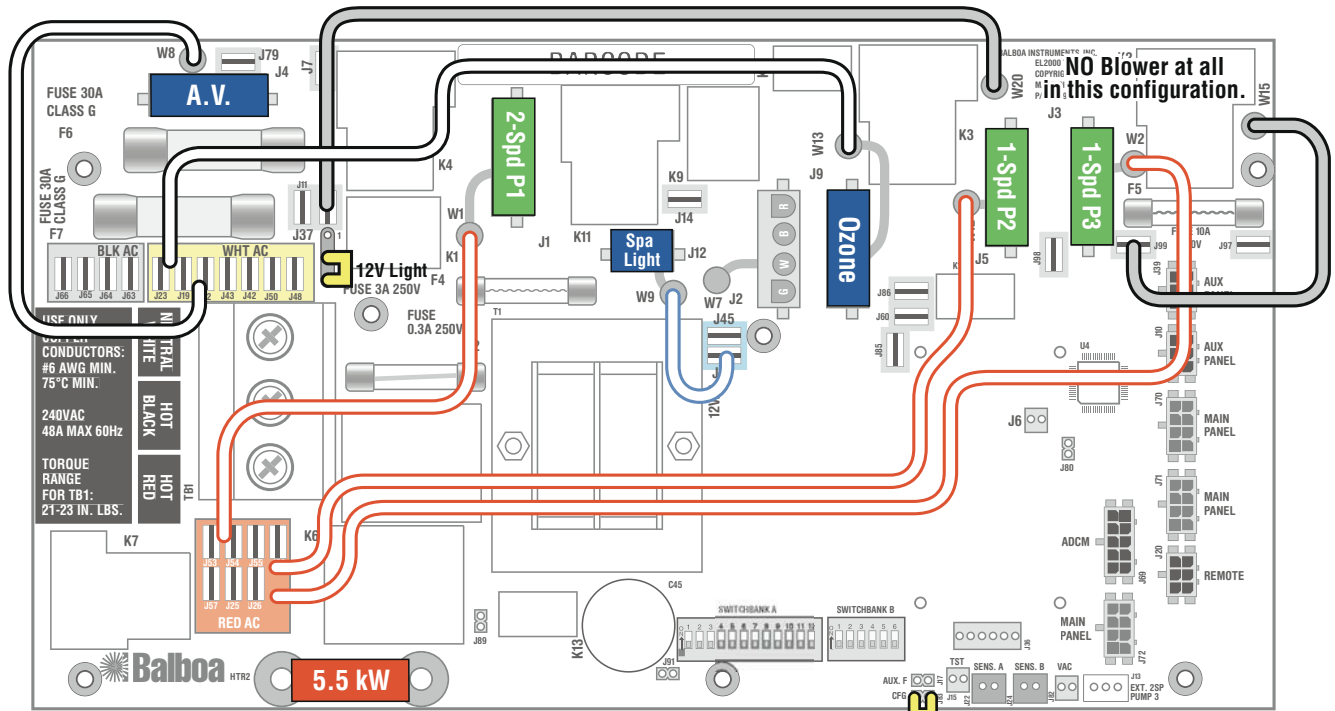

# Wiring Configuration



## Wiring Color Key

-  120 Volt Connections
-  240 Volt Connections
-  Black AC Jumpers
-  12 Volt Connections

# Configuration Options

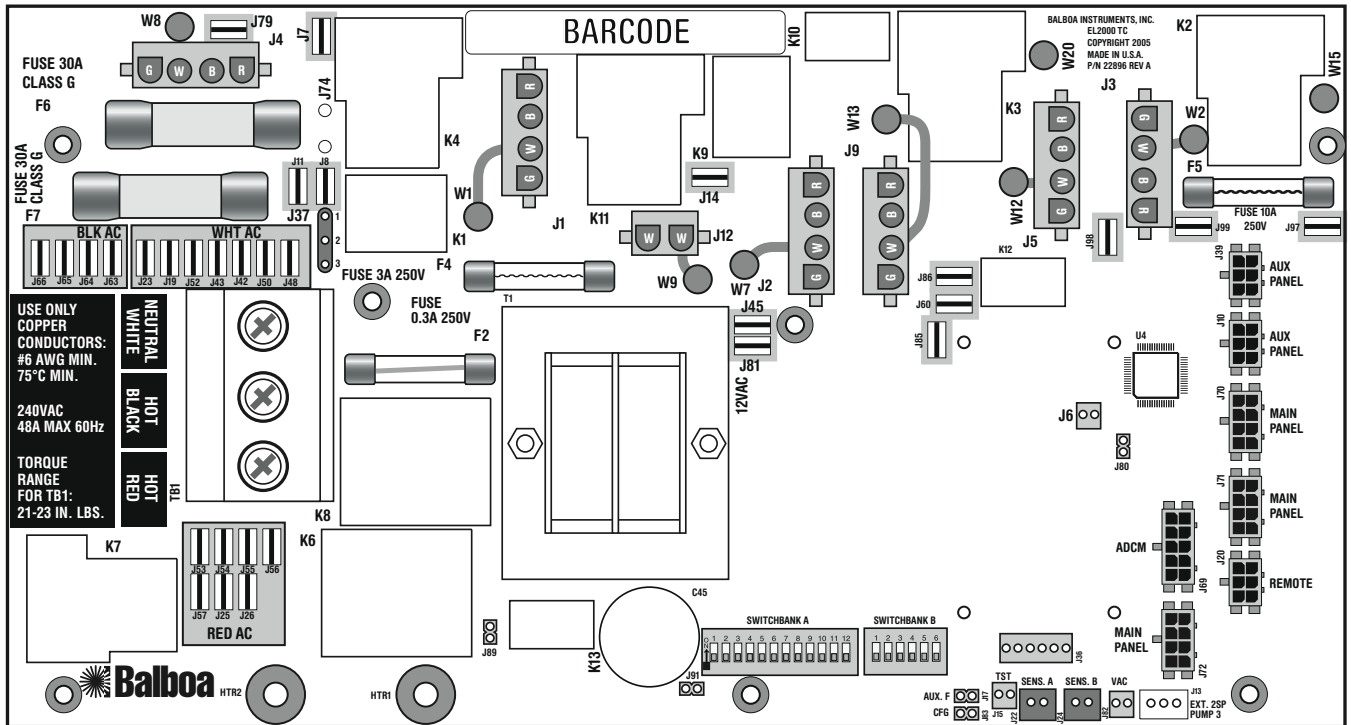

- J1 + W1 - 2-Speed Pump 1
- J2 + W7 - Circ Pump (Separate Relay 120V or 240V)
- J3 + W2 - 1-Speed Blower (with 1-speed Pump 2) W15 to J97  
- OR 1-Speed Pump 3 (with 1-speed Pump 2) W15 to J99
- J4 + W8 - Audio Visual (always hot - no relay)
- J5 + W12 - 2-Speed Pump 2 (with NO Blower on J3) W15 to J98  
- OR 1-Speed Pump 2 (See J3/W2)
- J9 + W13 - Ozone (Separate Relay 120V or 240V)
- J12 + W9 - Spa Light (12V or 120V)

## Legend Code Format:

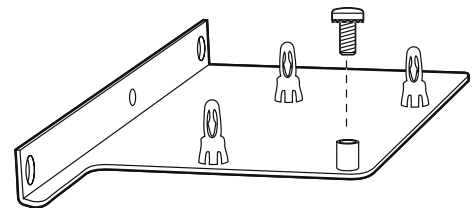
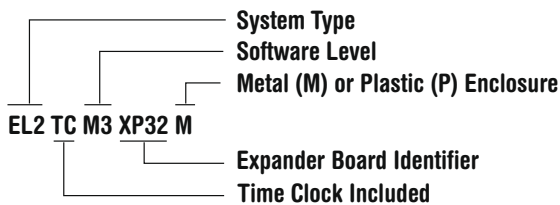

**X-Mount M** **PN 53914**  
 Used for mounting any Expander Board  
 in a metal enclosure for the EL2000.  
 Bracket attaches to heater mounting straps

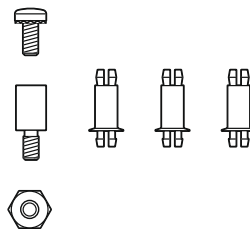

**X-Mount P** **PN 53933**  
 Used for mounting any Expander Board  
 in a plastic enclosure.  
 Standoffs attach to heater mounting bracket.

# Expander Options

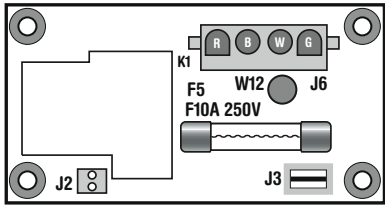

**X-B** **PN 53310**

Used for a Blower output ONLY when Pump 2 (J5) is a 2-speed pump. (W15 connected to J98)

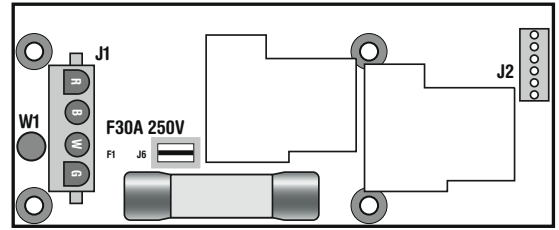

**X-P32** **PN 53680**

**(not released for EL2000 as of 07-14-05)**

Used for a 2-speed Pump 3 output when Pump 2 (J5) is a 2-speed pump. (W15 connected to J98)

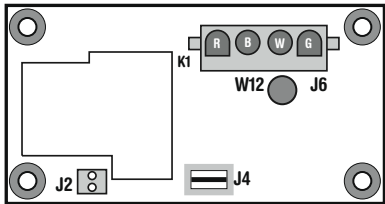

**X-P** **PN 53544**

Used for a 1-speed Pump 3 output when Pump 2 (J5) is a 1-speed pump and a blower is connected to J3. (W15 connected to J97)

Also used for a 1-speed Pump 4 when Pump 3 replaces a Blower on J3

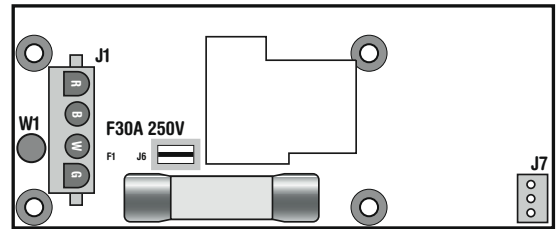

**X-P31** **PN 53681**

Can replace the X-P in cases where branch circuit protection is needed for high amperage devices that would over-burden power input fuse F7 on the main PCBA. This allows J6 on the X-P31 to connect directly to Black AC on the main EL2000 PCBA.

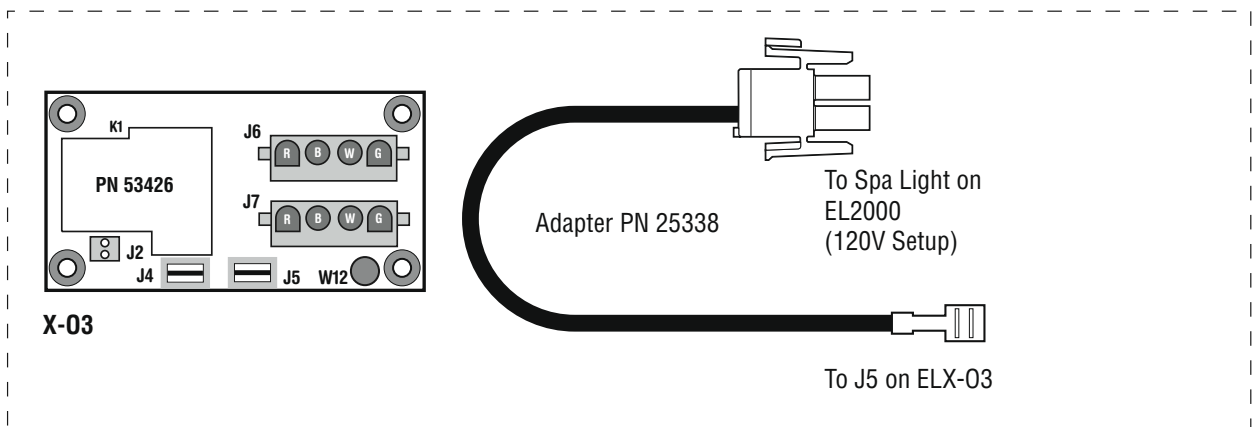

**X-03**

## X-FOW Kit

Special setup with X-03 and Adapter PN 25338 to operate a fiber-optic light and color wheel.

# DIP Switches and Jumpers

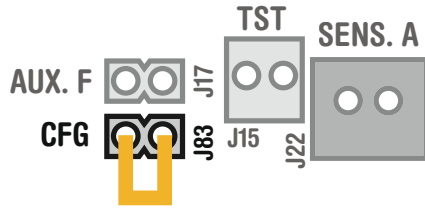

When the Logic Jumper is installed on J83 (CFG), Configuration Settings are enabled. DIP Switches will then operate as shown below.

## Switchbank A

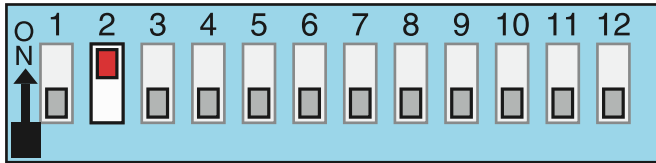

- |                     |                |
|---------------------|----------------|
| A1, Test Mode OFF   | A7, N/A        |
| A2, + 1 Pump w/Heat | A8, N/A        |
| A3,                 | A9, N/A        |
| A4,                 | A10, No Edit   |
| A5, N/A             | A11, N/A       |
| A6, N/A             | A12, Memory ON |

## Switchbank B

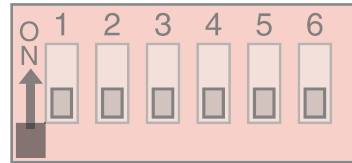

Switchbank B not used when Software Configuration Settings are enabled.

## J37

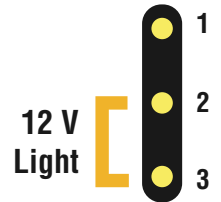

## J91



Note: A2/A3/A4 all off = No high-speed pumps or blower w/heat.

**J37** Jumper on Pin 1 and 2 will power one leg of J9 (Spa Light) at 120 Volts AC.

Jumper on Pin 2 and 3 will power one leg of J9 (Spa Light) at 12 Volts AC.

Note: W9 controls voltage on the other leg of J9 and must be set for the same voltage.

**J91** Jumper on 1 Pin only enables Real Time Clock function, for use with ML700 panel.

Jumper on Pin 1 and 2 disable RTC function for use with non-time capable panels (not included).

## DIP Switch Key

- A 1 ..... Test Mode (normally Off)
- A 2 ..... In "ON" position, add one high-speed pump (or blower) with Heater
- A 3 ..... In "ON" position, add two high-speed pumps (or 1 HS Pump and Blower) with Heater
- A 4 ..... In "ON" position, add four high-speed pumps (or 3 HS Pumps and Blower) with Heater
- A5 – 9 ..... N/A
- A 10 ..... When switched ON when spa is on, system will enter the Edit Menu for Configuration Settings. **Do not start spa with A10 turned on or CFE\* error will occur.**
- A 11 ..... N/A
- A 12 ..... Persistent memory reset (used when spa is powering up)

A2, A3, and A4 work in combination to determine the number of high-speed devices and blowers that can run before the heat is disabled. i.e. A2 and A3 in the ON position and A4 in the OFF position will allow the heater to operate with up to 3 high-speed pumps (or two HS Pumps and Blower) running at the same time. Heat is disabled when the fourth high-speed pump or blower is turned on.

Switchbank B is totally disabled (N/A)

\*CFE errors are illegal configurations such as a pump and a blower set to run on the same output. The configuration must be corrected before the spa will operate.

# Mach 3 Software Configuration Settings

The Edit menu for Configuration Settings is accessed by turning DIP switch A10 On while the spa is powered up. The Configuration Setting Edit menu will automatically be entered. After all desired changes are made to the settings, switch A10 should be turned Off, which will automatically reset the spa controller to load the new settings.

<i>Fd</i>	Program Filter Cycles by Duration	<input checked="" type="radio"/> Y <b>n</b> = Start and stop times; <b>Y</b> = Duration
<i>F1</i>	Pump 1 in Filter (w/Circ Pump)	<input checked="" type="radio"/> Y (This feature is used in Circ Mode only.) Allows P1 low to operate in Filter Cycles to add extra filtration. <b>n</b> = Normal; <b>Y</b> = Pump 1 with Circ
<i>24</i>	24-Hour Time	<input checked="" type="radio"/> Y <b>n</b> = 12-hour (am/pm); <b>Y</b> = 24-hour (military)
<i>tC</i>	Celsius	<input checked="" type="radio"/> Y <b>n</b> = Fahrenheit; <b>Y</b> = Celsius
<i>t0</i>	Timeouts	1 <input checked="" type="radio"/> F 2 3 4 5 6 <b>1-6</b> = 10, 20, 30, 40, 50, 60 minutes; <b>F</b> = 15 minutes
<i>1t</i>	Pump 1 Low Timeout	d 1 <input checked="" type="radio"/> 2 3 4 <b>d</b> = Use "Timeouts" value above; <b>1-4</b> = number of hours
<i>Lt</i>	Light Timeout	d 1 2 3 <input checked="" type="radio"/> 4 <b>d</b> = Use "Timeouts" value above; <b>1-4</b> = number of hours
<i>Sc</i>	Scrunch Panel	<input checked="" type="radio"/> Y <b>n</b> = Normal panel layout; <b>Y</b> = Alternate panel layout (ML900 scrunching enabled - ML550/700 Jets 3 replaces Blower
<i>cL</i>	Circ Type (behavior)	<input checked="" type="radio"/> A 3 P <b>n</b> = Non circ or circ pump not plumbed with heater; <b>A</b> = 24-hour; <b>3</b> = 24-hour w/ 3°F shutoff outside filter; <b>P</b> = Acts like Pump 1 Low (filter cycles, polls, etc.)
<i>P1</i>	Pump 1 Speeds	1 <input checked="" type="radio"/> 2 <b>1</b> = 1 speed; <b>2</b> = 2 speed
<i>P2</i>	Pump 2 Speeds	0 <input checked="" type="radio"/> 1 2 <b>0</b> = Disabled; <b>1</b> = On/Off; <b>2</b> = 2 speed
<i>P3</i>	Pump 3 Speeds	0 <input checked="" type="radio"/> 1 E H L <b>0</b> = Disabled; <b>1</b> = On/Off on board; <b>E</b> = External X-P Relay; <b>H</b> = On/Off on X-P31 board; <b>L</b> = 2 speed on X-P32 board
<i>P4</i>	Pump 4 Speeds	<input checked="" type="radio"/> 1 <b>0</b> = Disabled; <b>1</b> = On/Off

# Software Configuration Settings Continued

<i>bl</i>	Blower Speeds	<b>0</b> 1 <b>0</b> = Disabled; <b>1</b> = On/Off;
<i>fo</i>	Fiber Optics	<b>n</b> Y o <b>n</b> = Disabled; <b>Y</b> = Light and Wheel Enabled; <b>o</b> = On/Off only Fiber Light Enabled on Alarm Relay
<i>cc</i>	Cleanup Cycles	<b>0</b> 1 2 3 4 <b>0</b> = Disabled; <b>1-4</b> = Number of hours
<i>cu</i>	Cleanup Cycles as User Preference	<b>n</b> Y <b>n</b> = Only in Config Settings; <b>Y</b> = Over-rideable by User via User Preferences
<i>o3</i>	Ozone Operation	<b>A</b> F <b>A</b> = Operates with Heater Pump (Pump 1 Low or Circ Pump); <b>F</b> = Operates in Filter and Cleanup Cycles only
<i>os</i>	Ozone Suppression	<b>n</b> Y <b>n</b> = No Suppress; <b>Y</b> = 1-hour suppress on button press
<i>oi</i>	Ozone Icon	n <b>Y</b> <b>n</b> = O <sub>3</sub> Icon on Panels Disabled; <b>Y</b> = O <sub>3</sub> Icon on Panels Enabled
<i>A1</i>	Aux Button 1	<b>1</b> 2 3 4 5 6 b g F E o t d P n A U r O H
<i>A2</i>	Aux Button 2	1 <b>2</b> 3 4 5 6 b g F E o t d P n A U r O H
<i>A3</i>	Aux Button 3	1 2 3 4 5 6 <b>b</b> g F E o t d P n A U r O H
<i>A4</i>	Aux Button 4	1 2 3 4 5 6 b g F <b>E</b> o t d P n A U r O H
<p><b>1-6</b> = Assigns Pump Number (P1, P2 etc); <b>b</b> = Blower;  <b>g</b> = Spa Light; <b>F</b> = Fiber-Optic wheel/light; <b>E</b> = Either Light;  <b>o</b> = Option; <b>t</b> = Mister; <b>d</b> = CK Mode; <b>P</b> = CK Option;  <b>n</b> = CK Intensity; <b>A</b> = ACD Aroma; <b>U</b> = Button Disabled;  <b>r</b> = Air Valve; <b>O</b> = Option 2; <b>H</b> = Option 3</p>		
<i>sr</i>	Suppress all Reminders	n <b>Y</b> <b>n</b> = Display Reminders; <b>Y</b> = Suppress all Reminders



# Software Configuration Settings Continued

<i>rP</i>	Check pH Reminder Period	0	<b>1</b>	2	3	4	5	6	7	8	9	t
<i>rS</i>	Check Sanitizer Reminder Period	0	<b>1</b>	2	3	4	5	6	7	8	9	t
<i>rF</i>	Clean Filter Reminder Period	0	1	2	<b>3</b>	4	5	6	7	8	9	t
<i>rG</i>	Test GFCI Reminder Period	0	1	2	<b>3</b>	4	5	6	7	8	9	t
<i>rd</i>	Drain Water Reminder Period	0	1	2	3	4	5	<b>6</b>	7	8	9	t
<i>rA</i>	Change Mineral Cartridge	<b>0</b>	1	2	3	4	5	6	7	8	9	t
<i>rC</i>	Clean Cover Reminder Period	0	1	2	3	4	5	6	7	<b>8</b>	9	t
<i>ro</i>	Treat Wood Reminder Period	0	1	2	3	4	5	6	7	<b>8</b>	9	t
<i>rt</i>	Change Filter Reminder Period	0	1	2	3	4	5	6	7	8	<b>9</b>	t

**0** = Off; **1** = 7 days; **2** = 14 days; **3** = 30 days; **4** = 45 days; **5** = 60 days; **6** = 90 days; **7** = 120 days; **8** = 180 days; **9** = 365 days; **t** = 21 days

<i>St</i>	Set Default Temperature	5	6	7	8	9	<b>0</b>	1	2	3	4	E	F	n
-----------	-------------------------	---	---	---	---	---	----------	---	---	---	---	---	---	---

**5** = 95°F/35.0°C; **6** = 96°F/35.5°C; **7** = 97°F/36.0°C; **8** = 98°F/36.5°C; **9** = 99°F/37.0°C; **0** = 100°F/37.5°C; **1** = 101°F/38.0°C; **2** = 102°F/38.5°C; **3** = 103°F/39.0°C; **4** = 104°F/40.0°C; **E** = 80°F/26.5°C; **F** = 85°F/29.0°C; **n** = 99°F/32.0°C

<i>Fr</i>	Freeze Temperature Threshold	3	<b>4</b>	9	5
-----------	------------------------------	---	----------	---	---

**3** = 39°F; **4** = 44°F; **9** = 49°F; **5** = 54°F;

<i>tL</i>	Set Temperature Lock	<b>t</b>	S
-----------	----------------------	----------	---

**t** = Temp Lock Only; **S** = Temp + Settings Lock

<i>Lc</i>	Light Cycle Programming	<b>n</b>	Y
-----------	-------------------------	----------	---

**n** = Disabled; **Y** = Enabled

<i>1r</i>	Filter 1 Start Hour	<b>-</b>	0	1	2	3	4	5	6	7	8	9	A	b	C	d	E	F	g	H	J	L	n	o	P	r
<i>1d</i>	Filter 1 Duration	<b>-</b>	0	1	2	3	4	5	6	7	8	9	A	b	C	d	E	F	g	H	J	L	n	o	P	r
<i>2r</i>	Filter 2 Start Hour	<b>-</b>	0	1	2	3	4	5	6	7	8	9	A	b	C	d	E	F	g	H	J	L	n	o	P	r
<i>2d</i>	Filter 2 Duration	<b>-</b>	0	1	2	3	4	5	6	7	8	9	A	b	C	d	E	F	g	H	J	L	n	o	P	r

**-** = Standard Defaults; **0** = 0 (12am, 24); **1-9** = 1-9; **A** = 10; **b** = 11; **C** = 12; **d** = 13 (1 pm); **E** = 14 (2 pm); **F** = 15 (3 pm); **g** = 16 (4 pm); **H** = 17 (5 pm); **J** = 18 (6 pm); **L** = 19 (7 pm); **n** = 20 (8 pm); **o** = 21 (9 pm); **P** = 22 (10 pm); **r** = 23 (11 pm)

These settings allow customization of the filter defaults. If any of these four settings is **-**, the standard filter defaults are used. **1d** and **2d** cannot both be set to **0**.

When **Fd.n** is selected, **1d** and **2d** are Filter 1 and Filter 2 Duration specifically.

When **Fd.y** is selected:

If **1d** is set to **0**, **2d** is the duration; otherwise 1d is the duration.

If **1d** is set to **0**, only the Night cycle runs.

If **2d** is set to **0**, only the Day cycle runs.

If neither **1d** nor **2d** is set to **0**, both the Day and Night cycles run.

# Software Configuration Settings Continued

<i>PP</i>	Pump Purge Duration	3 <b>1</b> 2 5 t <b>3</b> = 30 seconds; <b>1 - 5</b> = 1 - 5 minutes; <b>t</b> = 10 minutes
<i>bP</i>	Blower Purge Duration	5 1 2 <b>3</b> 4 6 t F <b>5</b> = 5 seconds; <b>1</b> = 10 seconds; <b>2</b> = 20 seconds; <b>3</b> = 30 seconds; <b>4</b> = 45 seconds; <b>6</b> = 60 seconds (1 minute); <b>t</b> = 2 minutes; <b>F</b> = 5 minutes
<i>tP</i>	Mister Purge Duration	<b>5</b> 1 2 3 4 6 t F <b>5</b> = 5 seconds; <b>1</b> = 10 seconds; <b>2</b> = 20 seconds; <b>3</b> = 30 seconds; <b>4</b> = 45 seconds; <b>6</b> = 60 seconds (1 minute); <b>t</b> = 2 minutes; <b>F</b> = 5 minutes
<i>Ar</i>	Air Valve	<b>n</b> Y <b>n</b> = Disabled; <b>Y</b> = Enabled
<i>o2</i>	Option2	<b>n</b> Y <b>n</b> = Disabled; <b>Y</b> = Enabled
<i>o3</i>	Option3	<b>n</b> Y <b>n</b> = Disabled; <b>Y</b> = Enabled
<i>n1</i>	Dolphin Button 1	<b>1</b> 2 3 4 5 6 b g F E o t d P n A U r O H
<i>n2</i>	Dolphin Button 2	1 <b>2</b> 3 4 5 6 b g F E o t d P n A U r O H
<i>n3</i>	Dolphin Button 3	1 2 <b>3</b> 4 5 6 b g F E o t d P n A U r O H
<i>n4</i>	Dolphin Button 4	1 2 3 4 5 6 <b>b</b> g F E o t d P n A U r O H
<i>n5</i>	Dolphin Button 5	1 2 3 4 5 6 b <b>g</b> F E o t d P n A U r O H
<i>n6</i>	Dolphin Button 6	1 2 3 4 5 6 b g <b>F</b> E o t d P n A U r O H
<i>n7</i>	Dolphin Button 7	1 2 3 4 5 6 b g F E <b>o</b> t d P n A U r O H
<i>n8</i>	Dolphin Button 8	1 2 3 4 5 6 b g F E o <b>t</b> d P n A U r O H
		<b>1</b> = Pump 1; <b>2</b> = Pump 2; <b>3</b> = Pump 3; <b>4</b> = Pump 4; <b>5</b> = Pump 5; <b>6</b> = Pump 6; <b>b</b> = Blower; <b>g</b> = Spa Light; <b>F</b> = Fiber optic wheel/light; <b>E</b> = EitherLight; <b>o</b> = Option; <b>t</b> = Mister; <b>d</b> = Color Kinetics Mode; <b>P</b> = Color Kinetics Option; <b>n</b> = Color Kinetics Intensity; <b>A</b> = ACD Aroma Therapy; <b>U</b> = Button disabled; <b>r</b> = Air Valve; <b>O</b> = Option2; <b>H</b> = Option3
<i>co</i>	Color Kinetics	<b>n</b> Y <b>n</b> = Disabled; <b>Y</b> = Enabled
<i>cd</i>	ACD	<b>n</b> Y <b>n</b> = Disabled; <b>Y</b> = Enabled
<i>dr</i>	Drain Mode	<b>n</b> Y <b>n</b> = Disabled; <b>Y</b> = Enabled
<i>gf</i>	GFCI Test Enable	n <b>1</b> 2 3 4 5 6 7 <b>n</b> = Disabled; <b>1</b> = Auto after 1 day; <b>2</b> = Auto after 2 days; <b>3</b> = Auto after 3 days; <b>4</b> = Auto after 4 days; <b>5</b> = Auto after 5 days; <b>6</b> = Auto after 6 days; <b>7</b> = Auto after 7 days

# Ozone Connections

First, configure the EL Circuit Board to deliver the desired voltage to the on-board connector (J9). Connect the W13 wire to either White AC (120V) or Red AC (240V) to set the voltage.

The pin next to the bottom (ground) pin of J9 is fed by W13 and sets the voltage in the connector.

If the board is set up to operate a 120V ozone generator, the connector on the ozone generator is likely to be configured correctly, but should be compared to the illustration below.

If a 240V ozone generator is required, be sure the red wire in the ozone cord is positioned in the connector next to the green ground wire as described below.

*Note: A special tool is required to remove the pins from the connector body once they are snapped in place. Check with your Balboa Account Manager for information on purchasing a pin-removal tool.*

## Ozone connector configuration for 120V 60Hz

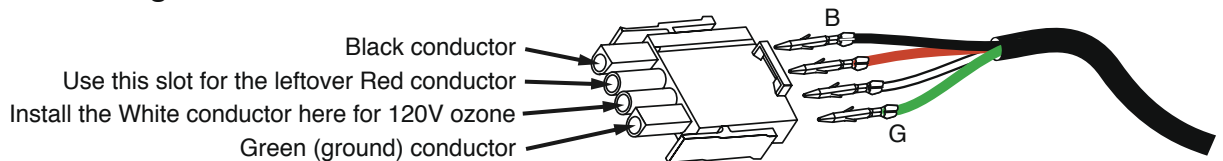

## Ozone connector configuration for 240V 60Hz

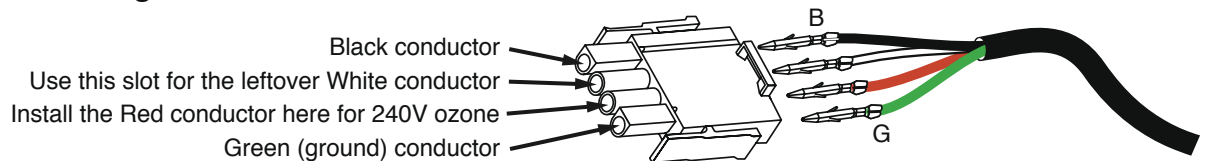

# Panel Configuration



ML 700

PN 53649

- Connects to Main Panel terminal J70, J71 or J72
- J91 must be on Off (1 Pin only)



AX 10

PN 52683

- Connects to Aux Panel terminal J10 or J39

## Auxiliary panels are available in the following configurations:

Infrared Remote (Dolphin) which has a separate connector on the board.

- 4-Button
- 2-Button
- 1-Button

Configuration of the 4-Button and 2-Button Aux Panels can be done for custom applications.

1-button Aux panels are available in 4 different versions.

There are two Aux Panel connectors on the board.