



**BP**  
Spa Control System



BALBOA  
water group

# BP200

## CUSTOMIZED TO FIT YOUR NEEDS

Smoothly integrates with bwa™, ControlMySpa™, bba™ and Balboa's Topside Panels.



### FEATURES

- Lowest cost, entry level BP system
- Attached or remote heater
- BP capable features
- Wireless System Control:  
(bwa™)/ControlMySpa™/Balboa Bluetooth Audio (bba™)
- Works with the newest TP/SpaTouch™ Panels

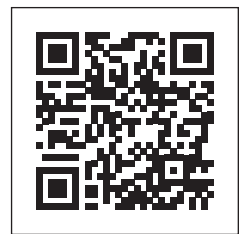

### FOR MORE INFORMATION

Visit us online: [www.balboawater.com/BP100/200](http://www.balboawater.com/BP100/200)

# BP200

## ENTRY LEVEL CONTROL SYSTEM

### SYSTEM SPECS

PRODUCT	VOLTAGE SUPPLY	SENSORS	SPA LIGHTS CONTROLS	PUMP	HEATER
BP200	230V	M7 Patented Temperature Probes	1 Amp Max at 10 volts	2-SPD Pump*	3.0 kW 800 incoloy**

\* Other configurations available

\*\* Other heaters available

### MOUNTING OPTIONS: FEET



#### WITH FEET

The system can be mounted with feet or brackets.



#### WITHOUT FEET

The system can be mounted with feet or brackets.

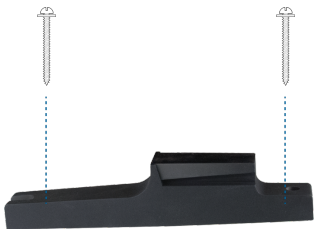

#### EACH FOOT

Is mounted to the surface with two screws.

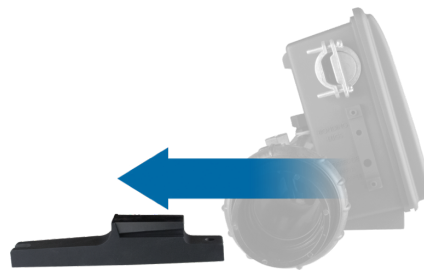

#### MOUNTING FEET

Once the feet are mounted, the system pack is mounted onto the feet in this direction.



#### SYSTEM PACK

Is mounted.

# BP200

## ENTRY LEVEL CONTROL SYSTEM

### MOUNTING OPTIONS: BRACKETS



#### VERTICAL BRACKETS

Mounting brackets can be installed vertically.



#### HORIZONTAL BRACKETS

Mounting brackets can be installed horizontally.



#### BRACKETS

The back of the system enclosure has holes for mounting brackets.

### ATTACHED HEATER



#### ATTACHED SPA HEATER

Built with premium materials, the attached spa heater is engineered for easy installation without any loose wires. All in one convenient package!

*Optional: Remote Heater available.*

# BP200

## ENTRY LEVEL CONTROL SYSTEM

### PANELS & OVERLAYS



#### TP Panels Shown

Works with all of Balboa's TP Panels



#### SpaTouch™ Panels Shown

Works with all of Balboa's SpaTouch™ Panels

#### Note

Please refer to Balboa's Topside Panels webpage or scan the QR code for part number and panel information. [www.balboawater.com/Topside-Panels](http://www.balboawater.com/Topside-Panels)

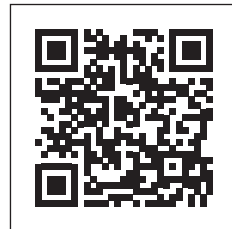

### DIMENSIONS

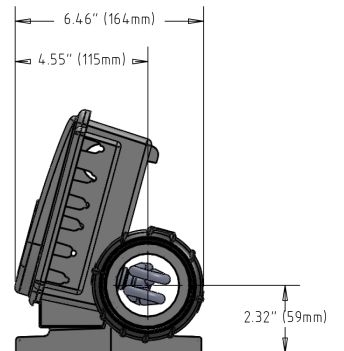
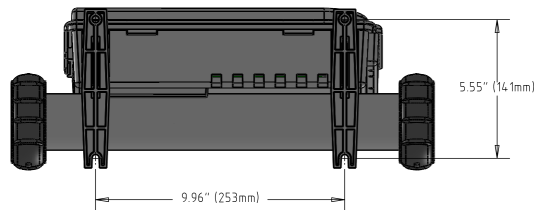
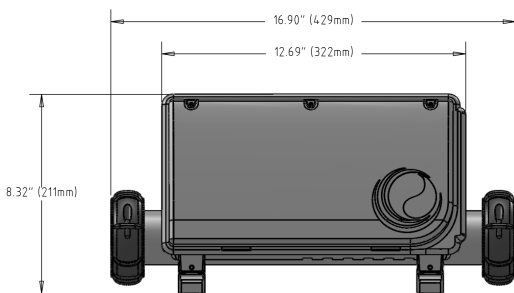

59189 | 2022 BP200

©2022 Balboa Water Group. Single Source Solution. All rights reserved.  
3030 Airway Avenue | Costa Mesa, CA 92626 | p 714.384.0384 | [www.balboawater.com](http://www.balboawater.com)  
Specifications subject to change without notice.

**BALBOA**  
water group  
A HELIOS COMPANY