

# EL2000 Mach 3 Hot Sheet

## Balboa Instruments System PN 53884-02

System Model # E2P-EL2000M3-YCAH  
Software Version # 26  
EPN # 2009

Base PCBA - PN 53834-02  
PCB EL2000 – PN 22896 Rev B

### Base Panels

ML900 – PN 52654  
ML700 – PN 52649  
ML400 – PN 52684



# Basic System Features and Functions

## Power Requirements

- 240VAC, 60Hz, 48A, Class A GFCI-protected service (Circuit Breaker rating = 60A max.)
- 4 wires (hot, hot, neutral, ground)

## System Outputs (As Configured)

- 240V Pump 1, 2-Speed
- 240V Pump 2, 1-Speed
- 240V Blower
- 240V Circ Pump
- 120V Ozone
- 12V Spa Light
- 120V AV (Stereo)
- 240V 5.5kW Heater

## Additional Options

- Full Feature Dolphin Remote and Spa-only Dolphin Remote  
Connects to Main Panel terminal J70 or J71 or J72
- Spa Monitor  
Connects to Remote terminal J20
- IR or RF Dolphin Receiver Module  
Connects to Remote terminal J20
- Ozone Generator  
Connects to terminal J9
- MoodEFX Lighting  
Connects to Spa Light terminal J12
- FiberEFX Lighting  
Connects to Spa Light terminal J12
- Stereo System  
Connects to A.V. terminal J4

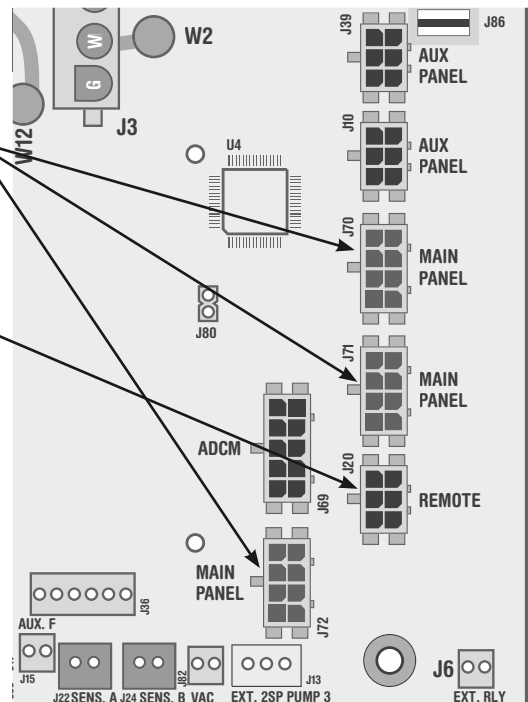

# Wiring Configuration

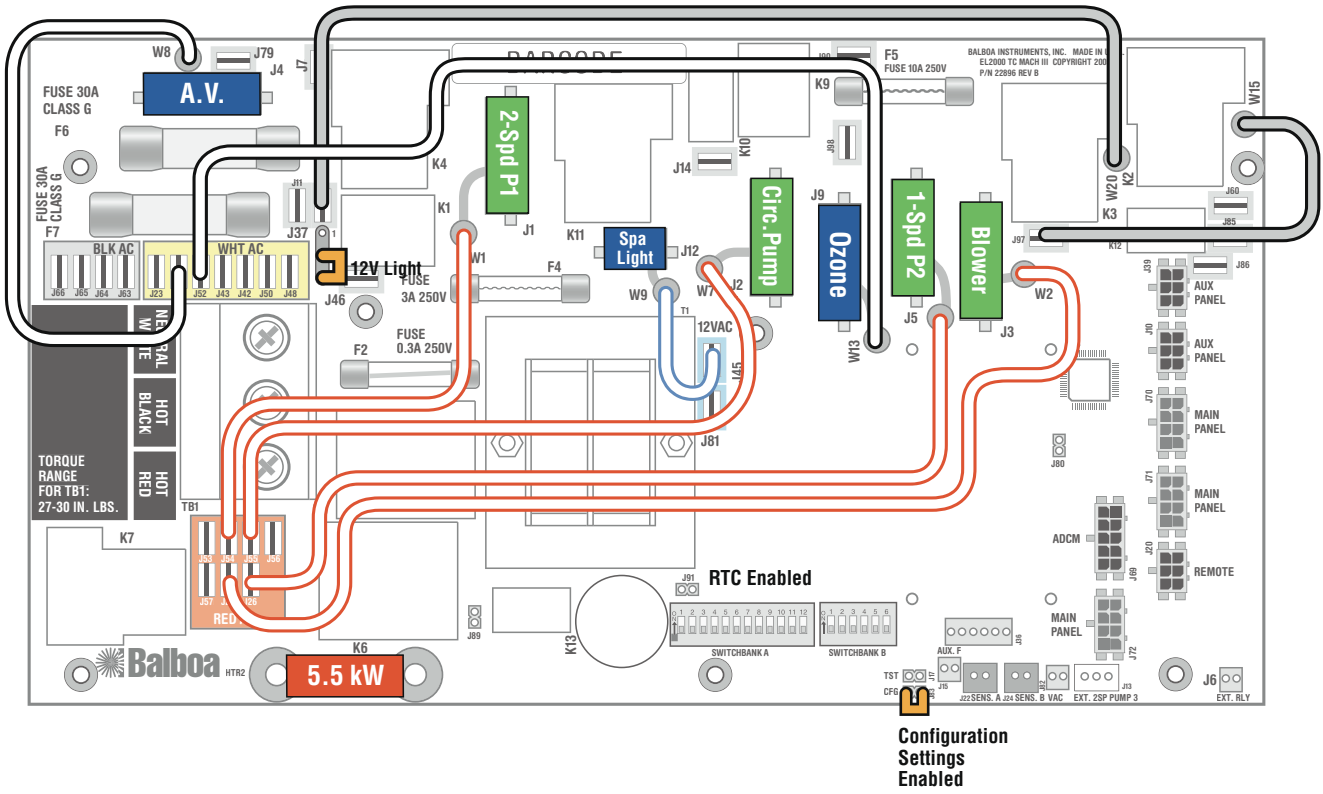

## Wiring Color Key

- 120 Volt Connections
- 240 Volt Connections
- Black AC Jumpers
- 12 Volt Connections
- Relay Control Wires

## Connector Key

- Typically Line voltage
  - Typically Line voltage for 2-speed pumps
  - Neutral (Common)
  - Ground
- Note flat sides in connector

PCB Revision	History
B	Production Release



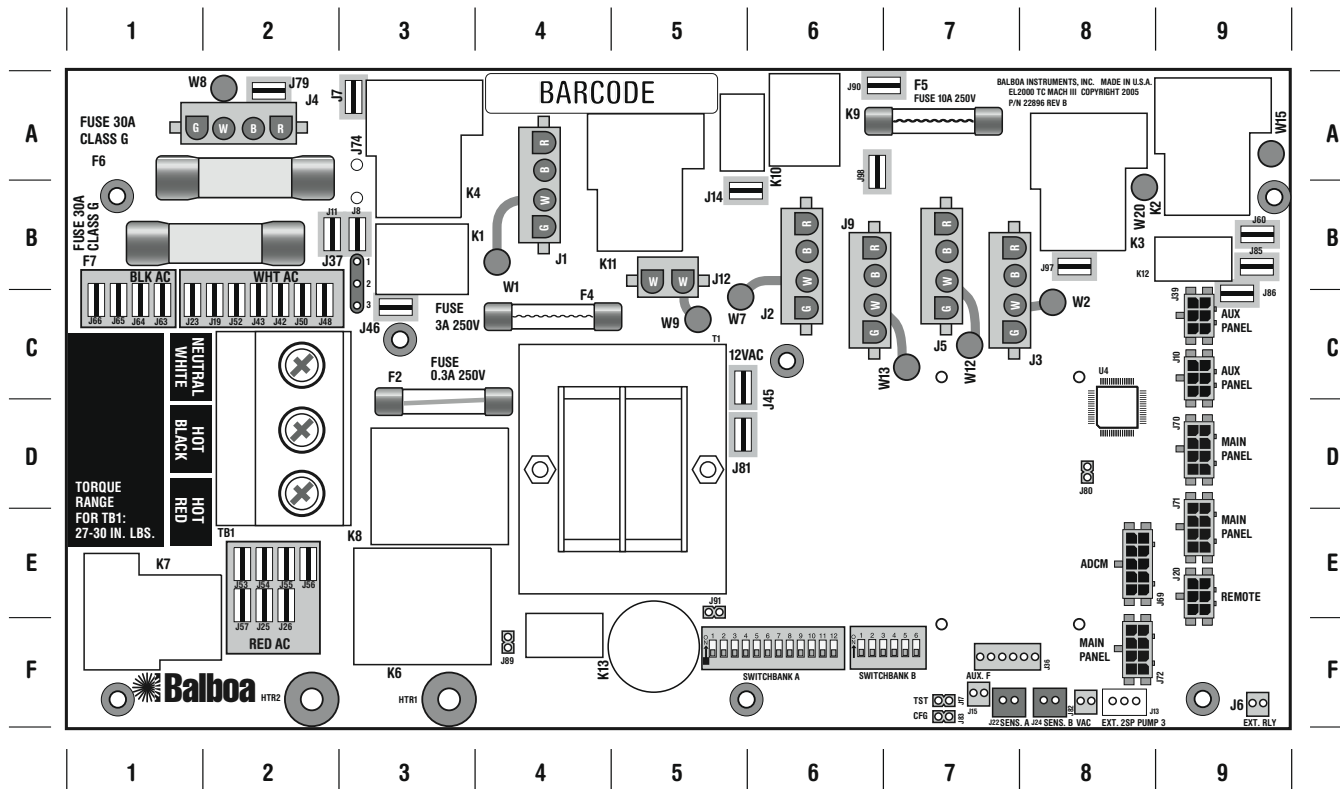

# Configuration Options



## Output Features

- |     |   |     |  |
|-----|---|-----|--|
| J1  | + | W1  | - 2-Speed Pump 1                                     |
| J2  | + | W7  | - Circ Pump (Separate Relay 120V or 240V)            |
| J3  | + | W2  | - 1-Speed Blower (with 1-speed Pump 2) W15 to J97    |
|     |   |     | - OR 1-Speed Pump 3 (with 1-speed Pump 2) W15 to J97 |
| J4  | + | W8  | - Audio Visual (always hot - no relay)               |
| J5  | + | W12 | - 2-Speed Pump 2 (with NO Blower on J3) W15 to J98   |
|     |   |     | - OR 1-Speed Pump 2 (See J3/W2)                      |
| J9  | + | W13 | - Ozone (Separate Relay 120V or 240V)                |
| J12 | + | W9  | - Spa Light (12V or 120V) Check J37 Setting          |

## Quadrant

- |     |  |
|-----|--|
| 4-A |  |
| 6-C |  |
| 7-C |  |
| 2-A |  |
| 7-C |  |
| 6-C |  |
| 5-B |  |

## X-Mount P

PN 53933

Used for mounting any Expander Board in a plastic enclosure. Standoffs attach to heater mounting bracket.

# Expander Options

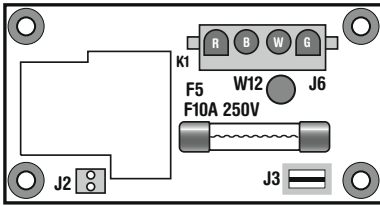

**X-B** **PN 53310**

Used for a Blower output ONLY when Pump 2 at J5 (7-B) is a 2-speed pump.

- W15 (9-A) connected to J98 (8-B)

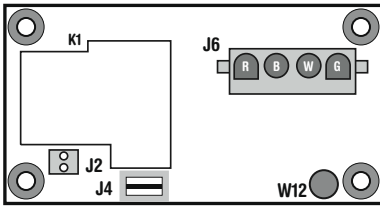

**X-P** **PN 53544**

Used for a 1-speed Pump 3 output when Pump 2 at J5 (7-B) is a 1-speed pump and a blower is connected to J3 (8-B).

- W15 (9-A) connected to J97 (9-B)

Also used for a 1-speed Pump 4 when Pump 3 replaces a Blower on J3 (9-B)

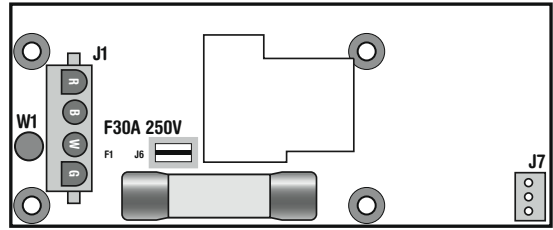

**X-P231** **PN 53681**

Can replace the X-P in cases where branch circuit protection is needed for high amperage devices that would over-burden power input fuse F7 (1-B) on the main PCBA. This allows J6 on the X-P231 to connect directly to Black AC (1-C) on the main EL2000 PCBA.

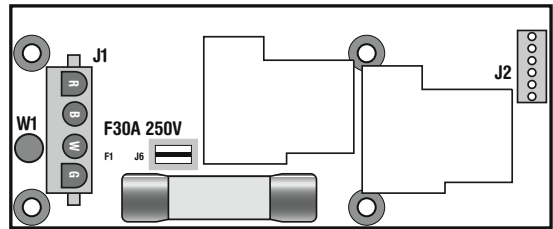

**X-P632** **PN 53680**

Used for a 2-speed Pump 3 output when Pump 2 at J5 (7-B) is a 2-speed pump or when Pump 2 is a 1-speed pump and a blower are on main PCBA.

- J6 on X-P632 connects directly to Black AC (1-C) on the main EL2000 PCBA.

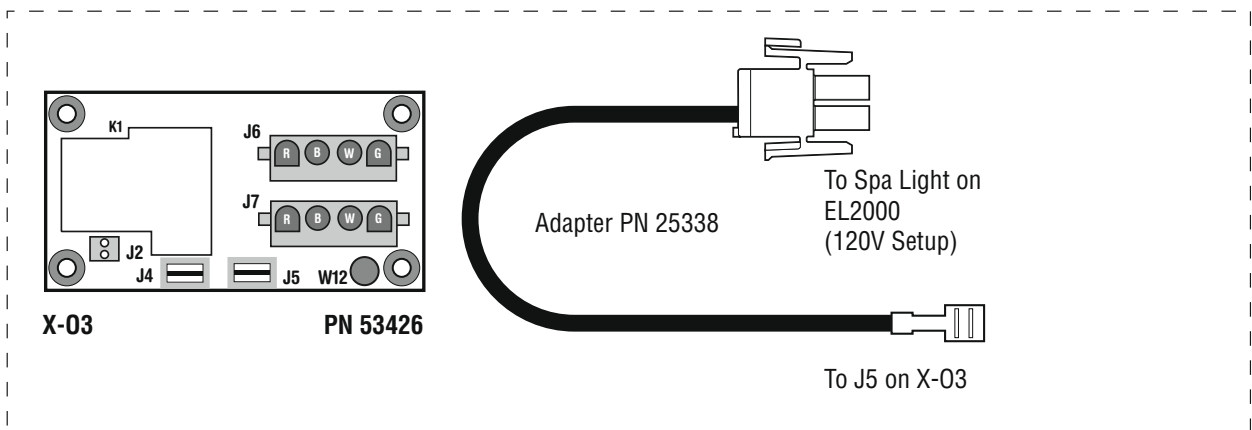

**X-03** **PN 53426**

**X-FOW Kit** **PN 53912**  
Special setup with X-03 and Adapter PN 25338 to operate a fiber-optic light and color wheel independently.

# DIP Switches and Jumpers

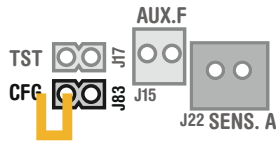

When the Logic Jumper is not installed on J83 (CFG), DIP Switch Settings are enabled. DIP Switches will then operate as shown below.

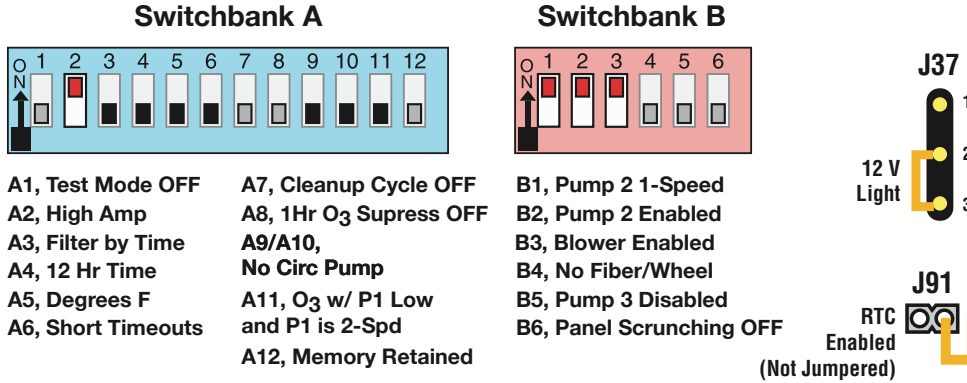

## DIP Switchbank A Key

- A1 ..... Test Mode (normally Off)
- A2 ..... In "ON" position, heater can run while any/all high-speed pumps or blowers are running. (High amperage)  
..... In "OFF" position, heater is disabled while any high-speed pump or blower is running. (Low amperage)
- A3 ..... In "ON" position, filter cycles are programmed by duration  
..... In "OFF" position, filter cycles are programmed to start and end times
- A4\* ..... In "ON" position, displays time in 24 hours (military\European time)  
..... In "OFF" position, displays 12 hour time
- A5\* ..... In "ON" position, displays temperature in Celsius  
..... In "OFF" position, displays temperature in Fahrenheit
- \* Sets default for user preferences - only applies when persistent memory is reset (A12 On) during power-up
- A6 ..... In "ON" position, Equipment timeout 30 minutes (4 hours for Pump 1-Low)  
..... In "OFF" position, Equipment timeout 15 minutes (2 hours for Pump 1-Low)
- A7 ..... In "ON" position, Cleanup Cycle – 30 minutes after spa use/timeout, Pump 1-Low & Ozone or Circ Pump and Ozone run for 1 hour.  
..... In "OFF" position, no Cleanup Cycle
- A8 ..... In "ON" position, Ozone suppression for one hour after pump/blower button press
- A9 and A10. .... See **Table** for Circ Pump Behavior settings
- A11 ..... In "ON" position  
..... **(non-circ mode operation)** Pump 1 is two-speed, Ozone is ON in Filter & Cleanup Cycles only  
..... **(in any circ mode)** Pump 1 is one-speed, Ozone is ON with circ pump  
..... In "OFF" position  
..... **(non-circ mode operation)** Pump 1 is two-speed, Ozone is ON with Pump 1-Low  
..... **(in any circ mode)** Pump 1 is two-speed, Ozone is ON with circ pump
- A12 ..... Persistent memory reset (normally off) (used when spa is powering up)

A9	A10	Circ Pump Behavior
OFF	OFF	No Circ Pump or Circ Pump not plumbed w/heater
ON	OFF	24 Hours
OFF	ON	24 Hr w/3°F Shut-Off
ON	ON	Acts like Pump 1-Low (Filter Cycles, Polls)

**J37** Jumper on Pin 1 and 2 will power one leg of J12 (Spa Light) at 120 Volts AC.

Jumper on Pin 2 and 3 will power one leg of J12 (Spa Light) at 12 Volts AC.

Note: W9 controls voltage on the other leg of J12 and must be set for the same voltage.

**J91** Jumper on 1 Pin only enables Real Time Clock function, for use with time capable panels.

Jumper on Pin 1 and 2 disable RTC function for use with non-time capable panels (not included).

# DIP Switches and Jumpers

## DIP Switchbank B Key

- B1 ..... In "ON" position, single-speed Pump 2  
..... In "OFF" position, two-speed Pump 2
- B2 ..... In "ON" position, Pump 2 enabled  
..... In "OFF" position, Pump 2 disabled
- B3 ..... In "ON" position, Blower enabled with Pump 2 low relay  
..... In "OFF" position, Blower disabled
- B4 ..... In "ON" position, Fiber and Wheel instead of Spa Light  
(on circ relay if A9, A10 off, external relay otherwise)  
..... In "OFF" position, Spa light enabled
- B5 ..... In "ON" position, Pump 3 enabled (Jets 3 replaces Blower on Aux panel)  
..... In "OFF" position, Pump 3 disabled
- B6 ..... In "ON" position, Alternate Panel layout  
(ML900 scrunching enabled - ML550 / 700 Jets 3 replaces Blower)  
..... In "OFF" position, Normal Panel layout

# Ozone Connections

**Ozone Connector Voltage:** The EL circuit board is factory configured to deliver a preset voltage (120V or 240V) to the on-board ozone connector (J9). See the ratings table on the wiring diagram attached to the cover of the enclosure for the configured voltage. For 240V output W13 connects to Red AC and for 120V output W13 connects to White AC.

The voltage to the ozone connector can be changed in the field if required. W13 just needs to be set for the required voltage.

**Balboa Ozone Generator:** If the board is set up to operate a 120V ozone generator, the connector on the ozone generator is likely to be configured correctly, but should be compared to the illustration below.

If a 240V ozone generator is required, be sure the red wire in the ozone cord is positioned in the connector next to the green ground wire as described below.

*Note: A special tool is required to remove the pins from the connector body once they are snapped in place. Check with your Balboa Account Manager for information on purchasing a pin-removal tool.*

## Balboa Ozone connector configuration for 120V 60Hz

- Line - Black conductor
- Use this slot for the leftover Red conductor
- Common - Install the White conductor here for 120V ozone
- Ground (Green) conductor

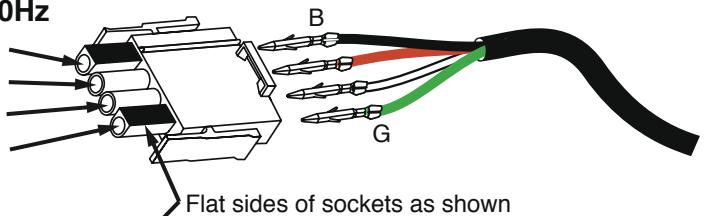

## Balboa Ozone connector configuration for 240V 60Hz

- Line - Black conductor
- Use this slot for the leftover White conductor
- Common - Install the Red conductor here for 240V ozone
- Ground (Green) conductor

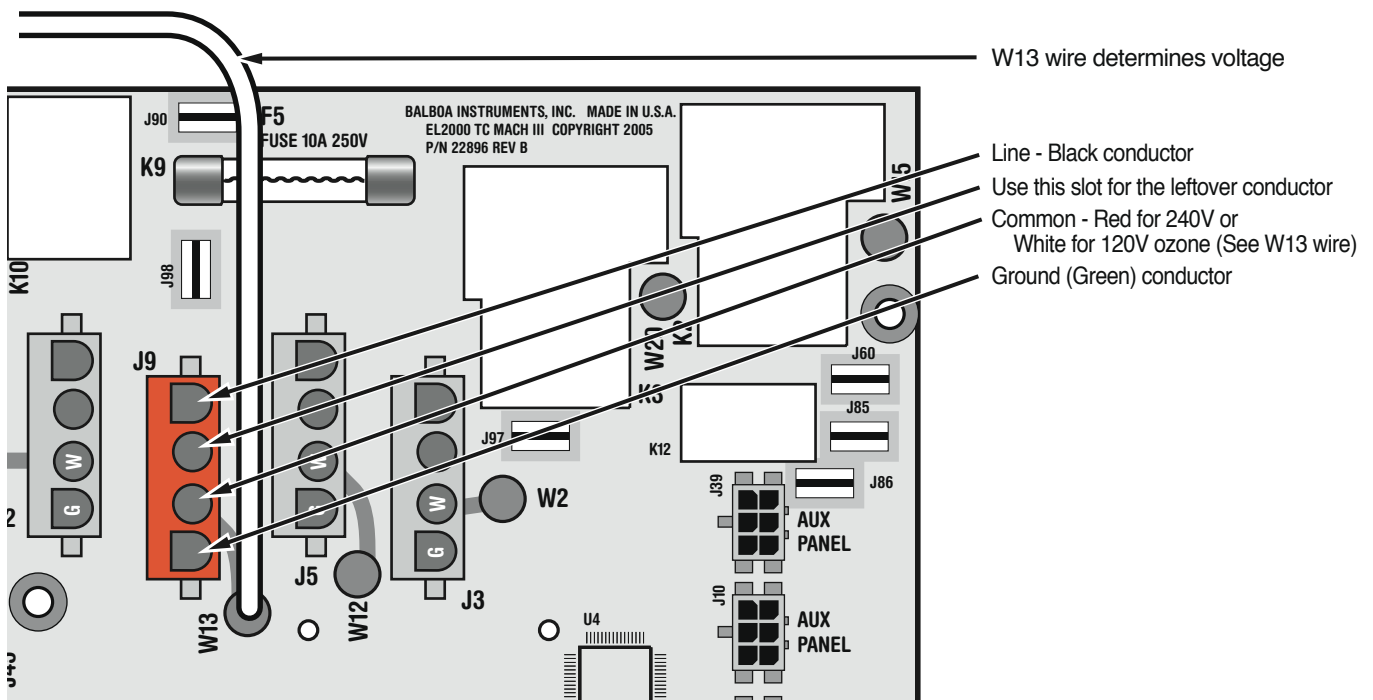
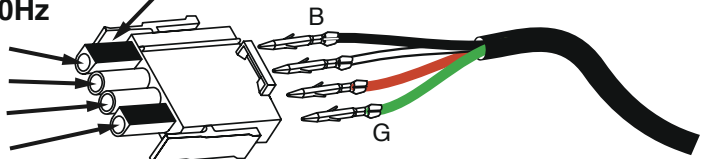



# Panel Configurations



## ML900

PN 52654 with Overlay PN 40026

- Connects to Main Panel terminal J70, J71, or J72
- RTC jumper (J91) on Main PCBA must be OFF (1 pin only)



## ML700

PN 52649 with Overlay PN 11281

- Connects to Main Panel terminal J70, J71, or J72
- RTC jumper (J91) on Main PCBA must be OFF (1 pin only)



## ML400

PN 52684 with Overlay PN 11345

- Connects to Main Panel terminal J70, J71, or J72
- RTC Jumper (J91) on Main PCBA must be ON (both pins jumpered)