

GL2001 Mach 3 Hot Sheet

Balboa Instruments System PN 53883-02

System Model # GL2-GL2001M3-RCA-3.0K

Software Version # 28

EPN # 2130

Base PCBA - PN 53975-02

PCB GL2000 – PN 22898 Rev B, C, or D

Base Panels

ML900 – PN 52654

ML700 – PN 52649

ML400 – PN 52684



Basic System Features and Functions

Power Requirements

- 230VAC, 1~, 16A or 32A, 50Hz or 230VAC (Line to Neutral), 3~, 16A, 50Hz

System Outputs

Setup 1 (As Manufactured)

- 230V Pump 1, 2-Speed
- 230V Pump 2, 2-Speed
- 230V Blower
- 230V Ozone
- 10V Spa Light
- 230V AV (Stereo)
- 230V 3.0kW Heater

Optional

- 230V Circ Pump

Additional Options

- Full Feature Dolphin Remote and Spa-only Dolphin Remote
Connects to Main Panel terminal J70 or J71 or J72
- Spa Monitor
Connects to Remote terminal J20
- IR or RF Dolphin Receiver Module
Connects to Remote terminal J20
- Ozone Generator
Connects to terminal J9
- MoodEFX Lighting
Connects to Spa Light terminal J12
- FiberEFX Lighting
Connects to Spa Light terminal J12
- Stereo System
Connects to A.V. terminal J4

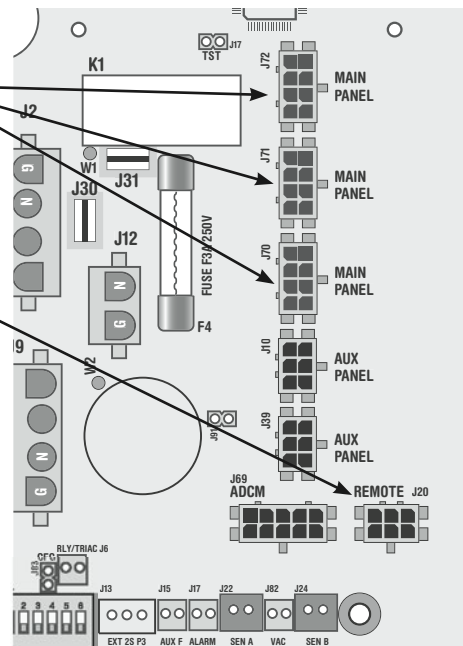

Persistent Memory and Powering Up

Any time you change DIP Switches or Software Configuration Settings that affect parameters the user can change (any filter settings, set temperature default, Celsius vs Fahrenheit, 12-hour vs 24-hour time, reminders suppression, etc), you must reset Persistent Memory for your DIP Switch or Software Configuration Settings changes to take effect. You should also reset Persistent Memory after loading a new file into a board (using the ESM, purchased separately).

To reset Persistent Memory:

- Power down.
- Set A12 ON (See illustration below).
- Power up.
- Wait until “P” or “PRIMING MODE” is displayed on your panel. Note: If “CFE” appears see section below.
- Set A12 OFF. (This can be done safely with power on if you use a non-conductive tool such as a pencil to push the switch back to the OFF position. Otherwise, power down before setting A12 OFF)
- Power up again (if you powered down in the previous step).
- For all other power ups, leave A12 OFF.

About Persistent Memory and Time of Day Retention:

This system uses memory that doesn't require a battery to store a variety of settings. What we refer to as Persistent Memory stores all the User Preferences, as well as all the filter settings, the set temperature, and the heat mode.

Persistent Memory is not used for Time of Day. Time of Day needs to be “kept running” (not just stored) while the power is off, so a separate Real Time Clock feature (on all models except the EL1000) keeps track of Time of Day while the unit is off. Time of Day Retention, and Time of Day Retention alone, is controlled by the J91 jumper. J91 must be set according to main system panel used.

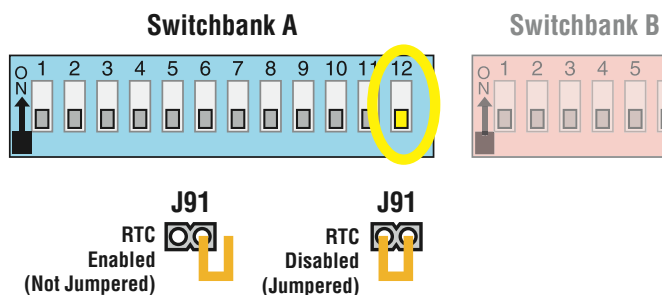

CFE message on power up:

If “CFE” appears before (and instead of) “P” or “PRIMING MODE”, you have not configured DIP Switches and/or Software Configuration Settings in a valid manner. This must be corrected before you can reset Persistent Memory.

The switch numbers, jumpers, or configuration settings displayed after “CFE” are ones with which the system has found a configuration problem. For example:

- “CFE A5 B2” would mean that the combination of how you’ve set A5 and how you’ve set B2 is not supported on this system.
- “CFE J99” would mean that there is a problem with jumper J99
- “CFE P3 1 BL 1” would mean that the combination of how you’ve set pump 3 for 1-speed and blower for 1-speed is not supported on this system.
- “CFE P3 BL” would mean that the combination of how you’ve set DIP switches which have been assigned to pump 3 and blower is not supported on this system.

Power Up Display Sequence

Upon power up, you should see the following on the display:

- Three numbers in a row, which are the SSID (the System Software ID). The third display of these numbers is the Software Version, which should match the version of your system. For example, if these three numbers are 100 134 26, that is a Mach 3 EL8000 at version 26.
- If there is a Configuration Error, the CFE message (see above) will appear at this point (and none of the messages below will display). Otherwise what comes next is:
- “3-6” (indicating the system is configured for a heater between 3 and 6 kW) or “1-3” (indicating the system is configured for a heater effectively* between 1 and 3 kW). “3-6” should appear for all EL models running at 240VAC. “1-3” should appear for all EL models running at 120VAC, as well as all GL models. (*A heater which is rated at 4 kW at 240VAC will function as a 1 kW heater at 120VAC.)
- If your system is using a special type of heater, a display such as “H 6” may appear next. If your system is using the generic Balboa heater, no heater type display will appear.
- “P” or “PRIMING MODE” will appear to signal the start of Priming Mode.

At this point, the power up sequence is complete. Refer to the User Guide for the ML Series panel on your system for information about how the spa operates from this point on.

Wiring Configuration and DIP Settings

Setup 1 (As Manufactured)

- 230V Pump 1, 2-Speed
- 230V Pump 2, 2-Speed
- 230V Blower
- 10V Spa Light
- 230V Ozone
- 230V AW (Stereo) Panel
- 230V 3.0kW Heater
- ML900 or ML700 Main Panel

HiPot Testing Note:

Disconnect slip terminal with green wires from J90 prior to performing HiPot test. Failure to disconnect will cause a false failure of the test.

Reconnect terminal to J90 after successful completion of HiPot test.

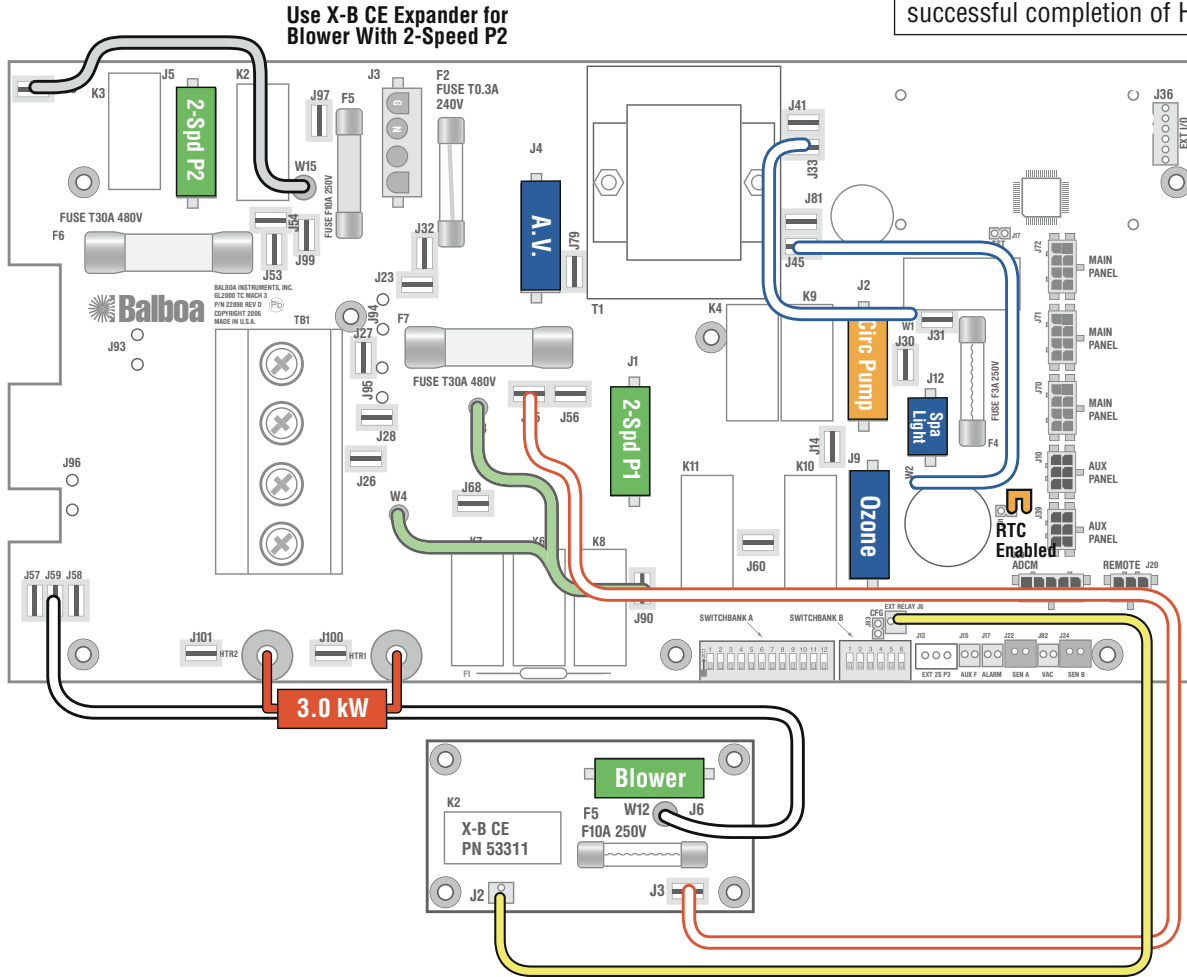

WARNING: Main Power to system should be turned OFF BEFORE adjusting DIP switches.

WARNING: Persistent Memory (A12) must be RESET to allow new DIP switch settings to take effect. (See Persistent Memory page)

When the Logic Jumper is not installed on J83 (CFG), DIP Switch Settings are enabled. DIP Switches will then operate as shown below.

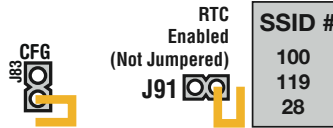

Switchbank A

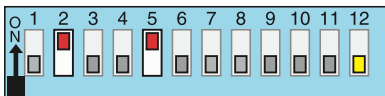

- A1, Test Mode OFF
- A2, High Amp
- A3, Filter by Time
- A4, 12 Hr Time
- A5, Degrees C
- A6, Short Timeouts
- A7, Cleanup Cycle OFF
- A8, 1Hr O₃ Suptess OFF
- A9/A10, No Circ Pump
- A11, O₃ w/ P1 Low and P1 is 2-Spd

A12, Memory Retained

Switchbank B

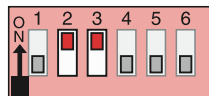

- B1, Pump 2 2-Speed
- B2, Pump 2 Enabled
- B3, Blower Enabled
- B4, No Fiber/Wheel
- B5, Pump 3 Disabled
- B6, Panel Scrunching OFF

Wiring Color Key

- Neutral (Common) AC Connections
- Special AC Connections
- Line AC Connections
- 10 Volt Connections
- Relay Control Wires

Connector Key

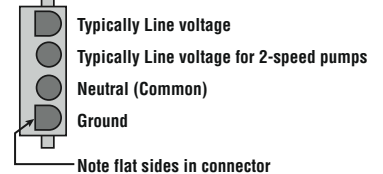

DIP Switches and Jumpers Definitions

WARNING:

- Setting DIP switches incorrectly may cause abnormal system behavior and/or damage to system components.
- Refer to Switchbank illustration on Wiring Configuration page for correct settings for this system.
- Contact Balboa if you require additional configuration pages added to this hot sheet.

DIP Switchbank A Key

- A1 Test Mode (normally Off)
- A2 In "ON" position, heater can run while any/all high-speed pumps or blowers are running (High amperage)
 In "OFF" position, heater is disabled while any high-speed pump or blower is running (Low amperage)
- A3 In "ON" position, filter cycles are programmed by duration for non-time capable panels
 In "OFF" position, filter cycles are programmed to start and end times for time capable panels
- A4* In "ON" position, displays time in 24 hours (military\European time)
 In "OFF" position, displays 12 hour time
- A5* In "ON" position, displays temperature in Celsius
 In "OFF" position, displays temperature in Fahrenheit
- * Sets default for user preferences - only applies when persistent memory is reset (A12 On) during power-up
- A6 In "ON" position, Equipment timeout 30 minutes (4 hours for Pump 1-Low)
 In "OFF" position, Equipment timeout 15 minutes (2 hours for Pump 1-Low)
- A7 In "ON" position, Cleanup Cycle – 30 minutes after spa use/timeout, Pump 1-Low & Ozone or Circ Pump and Ozone run for 1 hour
 In "OFF" position, no Cleanup Cycle
- A8 In "ON" position, Ozone suppression for one hour after pump/blower button press
- A9 and A10 See **Table** for Circ Pump Behavior settings
- A11 In "ON" position
 **(non-circ mode operation)** Pump 1 is two-speed, Ozone is ON in Filter & Cleanup Cycles only
 **(in any circ mode)** Pump 1 is one-speed, Ozone is ON with circ pump
 In "OFF" position
 **(non-circ mode operation)** Pump 1 is two-speed, Ozone is ON with Pump 1-Low
 **(in any circ mode)** Pump 1 is two-speed, Ozone is ON with circ pump
- A12 Persistent memory reset (normally off) (used when spa is powering up)

A9	A10	Circ Pump Behavior
OFF	OFF	No Circ Pump or Circ Pump not plumbed w/heater
ON	OFF	24 Hours
OFF	ON	24 Hr w/3°F Shut-Off
ON	ON	Acts like Pump 1-Low (Filter Cycles, Polls)

DIP Switchbank B Key

- B1 In "ON" position, single-speed Pump 2
 In "OFF" position, two-speed Pump 2
- B2 In "ON" position, Pump 2 enabled
 In "OFF" position, Pump 2 disabled
- B3 In "ON" position, Blower enabled with Pump 2 low relay
 In "OFF" position, Blower disabled
- B4 In "ON" position, Fiber and Wheel instead of Spa Light
 (if A9 & A10 are both OFF, Fiber uses J2 connector; if either A9 or A10 is ON, X-FOW Kit required to run Fiber)
 In "OFF" position, Spa light enabled
- B5 In "ON" position, Pump 3 enabled (Jets 3 replaces Blower on Aux panel)
 In "OFF" position, Pump 3 disabled
- B6 In "ON" position, Alternate Panel layout (ML900 scrunching enabled - ML550 / 700 Jets 3 replaces Blower)
 In "OFF" position, Normal Panel layout

Jumpers

- J91** Jumper on 1 Pin only enables Real Time Clock function; use with time capable panels.
 Jumper on Pins 1 and 2 disables RTC function; use with non-time capable panels.

Electrical Service Configuration Options

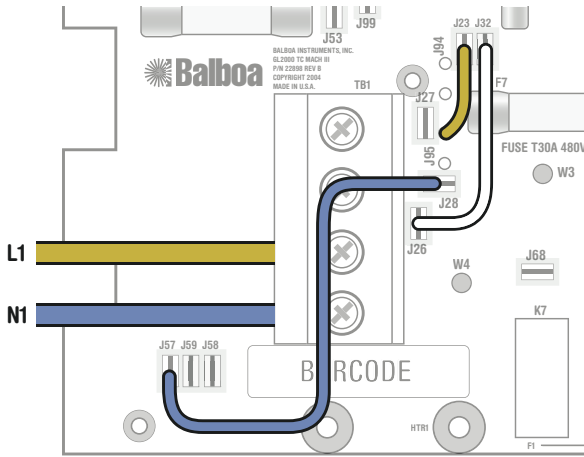

Single Service (1 x 16 Amp or 1 x 32 Amp)

This option is configured and shipped as the default.

For 1 x 32 Amp Service:

DIP Switch A2 can be ON

For 1 x 16 Amp Service:

DIP Switch A2 must be OFF

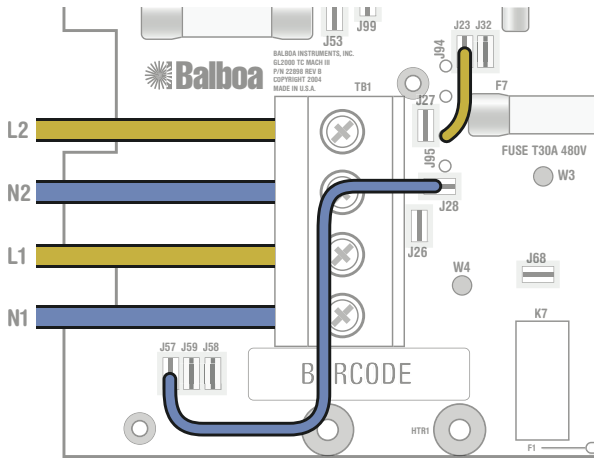

Dual Service Option (2 x 16 Amp)

Completely remove the white wire from J26 and J32.

Note: J32 and J23 are electrically identical. The white wire may be attached to either terminal before removal.

DIP Switch A2 must be ON

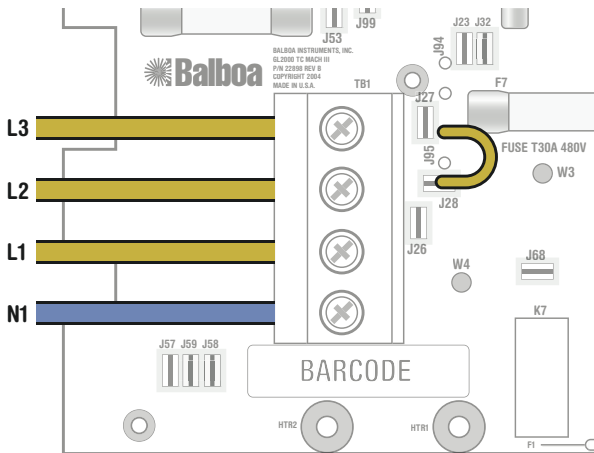

3-Phase Service Option

IMPORTANT - Service **MUST** include a neutral wire, with a line to neutral voltage of 230VAC.

Completely remove the white wire from J26 and J32.

Note: J32 and J23 are electrically identical. The white wire may be attached to either of these terminals before removal.

Completely remove the blue wire from J28 and J57.

Note: J57, J58 and J59 are electrically identical. The blue wire may be attached to any of these terminals before removal.

Move the brown wire from J23 or J32 to J28.

DIP Switch A2 must be ON

Configuration Options

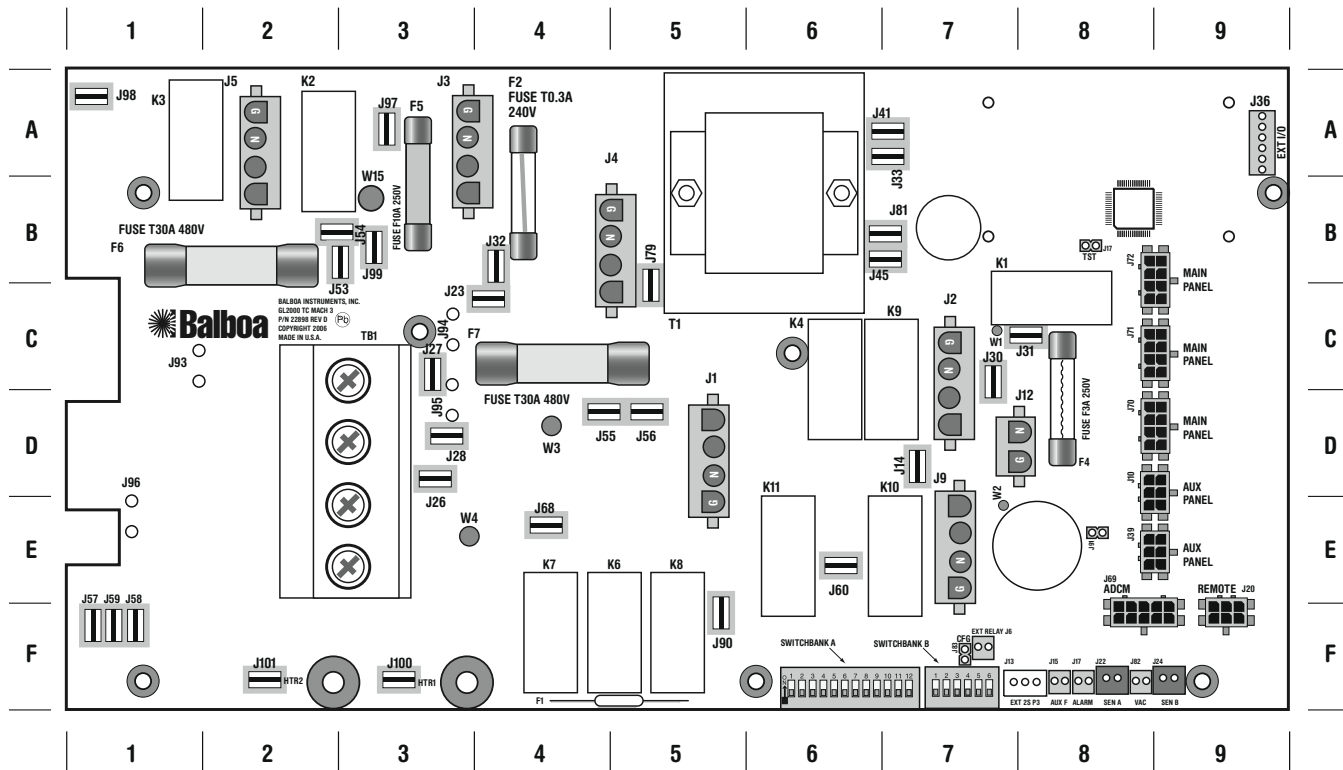

Output Features

- J1 2-Speed Pump 1
- J2 Circ Pump (Separate Relay)
OR Fiber Optic Light
- J3 1-Speed Blower (with 1-speed Pump 2) W15 to J97
OR 1-Speed Pump 3 (with 1-speed Pump 2) W15 to J99
- J4 Audio Visual (always hot - no relay)
- J5 2-Speed Pump 2 (with NO Blower on J3) W15 to J98
OR 1-Speed Pump 2 (See J3 and W15)
- J9 Ozone (Separate Relay)
- J12 Spa Light (10V or 230V)

Quadrant

- 5-D
- 7-C
- 3-A
- 5-B
- 2-A
- 7-E
- 8-D

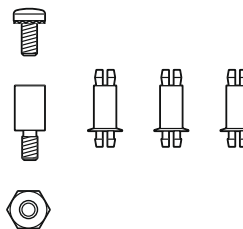

X-Mount P

PN 53933

Used for mounting any Expander Board in a plastic enclosure.
Standoffs attach to heater mounting bracket.

10 VAC Light Configuration

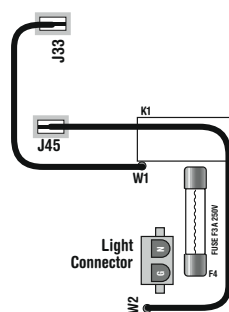

230 VAC Light Configuration

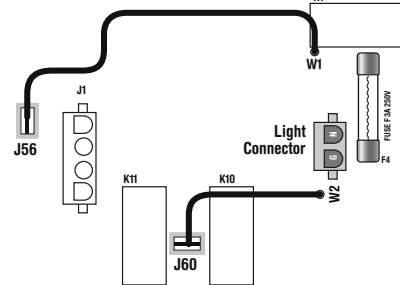

Expander Options

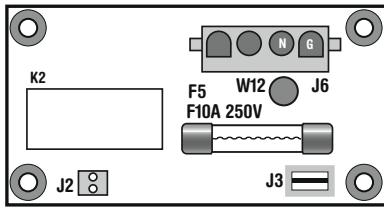

X-B CE PN 53311
Used for a Blower output ONLY when Pump 2 (J5) is a 2-speed pump. (W15 connected to J98)

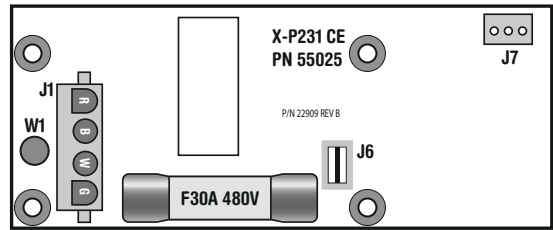

X-P231 CE PN 55025
Can replace the X-P CE in cases where branch circuit protection is needed for high amperage devices that would over-burden power input fuse F6 or F7 (4-C) on the main PCBA.
• J6 on X-P632 CE connects directly to Line AC Use J27, J32, or J26 on the main GL2000 PCBA, depending on AC Service Configuration.

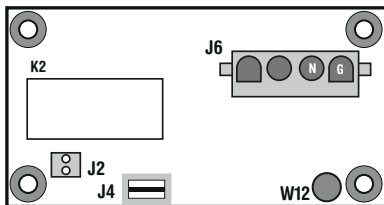

X-P CE PN 53547
Used for a 1-speed Pump 3 output when Pump 2 (J5) is a 1-speed pump and a blower is connected to J3. (W15 connected to J97)

Also used for a 1-speed Pump 4 when Pump 3 replaces a Blower on J3

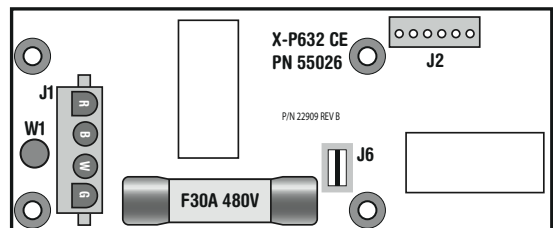

X-P632 CE PN 55026
Used for a 2-speed Pump output or for two 1-speed Pumps. Can also be used for other optional setups.
• J6 on X-P632 CE connects directly to Line AC Use J27, J32, or J26 on the main GL2000 PCBA, depending on AC Service Configuration.

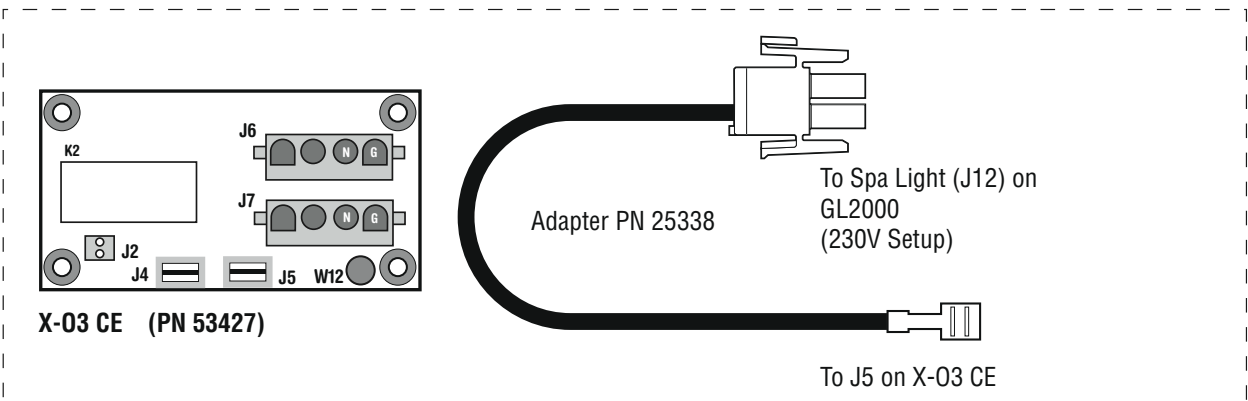

X-O3 CE (PN 53427)
X-FOW CE Kit PN 53976
Special setup with X-O3 CE and Adapter PN 25338 to operate a fiber-optic light and color wheel. Required when a Circ Pump is installed on Main PCBA at J2.

Panel Configurations



ML900

PN 52654 with Overlay PN 40026

- Connects to Main Panel terminal J70, J71, or J72
- RTC jumper (J91) on Main PCBA must be OFF (1 pin only)



ML700

PN 52649 with Overlay PN 11281

- Connects to Main Panel terminal J70, J71, or J72
- RTC jumper (J91) on Main PCBA must be OFF (1 pin only)



ML400

PN 52684 with Overlay PN 11345

- Connects to Main Panel terminal J70, J71, or J72
- RTC Jumper (J91) on Main PCBA must be ON (both pins jumpered)

TIME CAPABLE

NON-TIME CAPABLE