

# BP100G3 Tech Sheet

---

**Customer:** Balboa Water Group

**Part Number:** 59276-02 5.5kW 800 Incoloy  
59277-02 4.0kW 800 Incoloy

Custom Box Overlay   
Box Overlay Part Number N/A

UL System Model For 5.5kW: BP1-BP100G3-BU  
UL System Model For 4.0kW: BP1-BP100G3-BS  
Software Version ID: M100\_230 V52.0  
Software Version: 52.0  
File Name: BP100\_52.0\_BP100G3.hex  
Configuration Signature: 85A38E9D

Eng. Project Number: 5678

Control Panels (See later pages for more information):

spaTouch™2	Any version (version 2.0 or later required for bba™2 fully integrated functionality)
Icon spaTouch™	Any version (version 3.36 or later required for bba™2 fully integrated functionality)
Menued spaTouch™	Any version (version 2.8 or later required for bba™2 integrated functionality)
TP900	Version 3.1 and later (Version 3.13 or later required for bba™)
TP800	Version 3.1 and later (Version 3.13 or later required for bba™; version 4.11 or later required for bba™2 integrated functionality)
TP600	Version 2.7 and later (Version 2.12 or later required for bba™/bba™2 On/Off control via menu)
TP500	Any version
TTP400T US	Version 2.7 and later (TP400T CE may be used) (Version 2.12 or later required for bba™/bba™2 On/Off control via menu)
TP400W US	Version 2.7 and later (TP400W CE may be used) (Version 2.12 or later required for bba™/bba™2 On/Off control via menu)
TP200T	Any version
TP200W	Any version

Manufactured under one or more of these patents. U.S. Patents: 5332944, 5361215, 5550753, 5559720, 5,883,459, 6253227, 6282370, 6590188, 6976052, 6965815, 7030343, 7,417,834 b2, Canadian Patent: 2342614, Australian patent: 2373248 other patents both foreign and domestic applied for and pending. © Copyright 2009 Balboa Water Group.

# System Revision History

Part #	EPN	Date	Originator	Changes Made
59276 59277	5205	08-22-19	BWG	Generic BP100G3 system, supporting most of the Setups the BP100 board can do with a blower expander board.
59276-01 59277-01	5353	12-23-20	BWG	Update to new system board shape.
59276-02 59277-02	5678	04-21-22	BWG	Redesigned expander board, with Voltrex connector J7 instead of soldered wire connection W12.

bba™ 2 / bba™ 3 (Balboa Bluetooth Amp) connection is documented separately.

bba™ 2 / bba™ 3 is integrated into graphic display panels (TP700, TP800, TP900 and spaTouch™).

With TP600/TP500/TP400/TP200, use the "BT" entry on the menu to toggle bba™ 2 / bba™ 3 power On/Off.

# Basic Functions Setup 1 - 4

---

## Power Requirements:

240VAC, 50/60Hz\*, 48A, Class A GFCI-protected service (Circuit Breaker = 60A max.),  
4 wires [hot, hot, neutral, ground]

120/240VAC, 50/60Hz\*\*, 16/40A, Class A GFCI-protected service (Circuit Breaker = 20/50A max.) -- **Setups 3 & 4 Only**  
3 or 4 wires [hot, hot (optional), neutral, ground].

### \*\*NOTE:

The above 120V spec is only when using a wall-mount GFCI / breaker.

If using a GFCI cord, the breaker is 15A and so the service is limited to 12A.

\*BP systems automatically detect 50Hz vs 60Hz. However, power frequency (50Hz vs 60Hz) is just one of many differences between North American (UL) and CE power, and it is because of these other differences that different BP systems must be used for UL vs CE territories. Also, there are a few countries that use CE power but 60 Hz (such as South Korea) which need CE systems, and a few countries that use UL power but 50 Hz which need UL systems.

---

### HiPot Testing Note:

Disconnect slip terminal with green wires from J6 prior to performing HiPot test. Failure to disconnect may cause a false failure of the test. Reconnect terminal to J6 after successful completion of HiPot test.

# Basic Functions Setup 1 - 4

---

## System Outputs:

Pump 1	240VAC*	2-Speed	12A max	15-minute timer (30-minute timer for P1 Low in non-circ Setup 2 & 4 only) This is the heater pump in Setups 2 & 4. Must deliver 20 GPM through heater 1-Speed in Setups 1 & 3
Blower	240VAC	1-Speed	4A max	15-minute timer Unused in Setups 3 & 4
Circ Pump	240VAC*	1-Speed	2A max	Programmable Filtration Cycles + Polling This is the heater pump in Setups 1 & 3. Must deliver 20 GPM through heater
Ozone	240VAC*		.5A max	Slaved to Circ Pump in Circ Setups and to Pump 1 Low in Non-Circ Setups
Spa Light	10VAC	On/Off	1A max	240-minute timer.
A/V (Stereo)	120VAC	Hot	3A max	Always on
Heater	5.5kW @ 240VAC (approx 1.4kW @ 120VAC) 4.0kW @ 240VAC (1.0kW @ 120VAC)			

\*Pump 1, Circ Pump and Ozone must be the same voltage.

With 120VAC power input (for Setups 3 & 4 only), Pump 1, Circ pump and Ozone must all be 120V. See wiring diagram for rewiring instructions.

# Hardware Setup

## Wiring Diagram

04-20-21

TP (MAIN) PANELS  
J34 OR J35

BP100G3 PN 59276-02

LOCATION	DEVICE	VOLTS	MAX AMPS	FROM	TO
J9	2/1-SP PUMP 1	240V**	12A MAX		
J19	CIRC PUMP	240V**	2A MAX	J46	AREA 3
J21	OZONE	0.5A			
	CIRC AND OZONE	LINE 1 CONNECTION		J51, J52	AREA 2
J33	TV / AV	120V*	3A	J38	AREA 1
J15	SPA LIGHT	10V	1A		
J11 & J13	HEATER	240V	5.5 kW (1.4kW @120V)		

\*FOR 240V AV, MOVE J38 WIRE TO AREA 3  
\*\*PUMP 1, CIRC AND OZONE ALL MUST BE THE SAME VOLTAGE.

USE EARTH GROUND CONNECTIONS AS INDICATED INSIDE SYSTEM ENCLOSURE

TOTAL OUTPUT AMP DRAW NOT TO EXCEED MAX INPUT RATING OF SPA

INSTEAD OF SETUP #2, THIS SYSTEM IS CONFIGURED IN SETUP #:

1	FILTERS + POLLING
2	NONE
3	FILTERS + POLLING
4	NONE

FOR SUPPLY CONNECTIONS, USE CONDUCTORS SIZED ON THE BASIS OF 60°C AMPACITY BUT RATED MINIMUM OF 90°C.

NOTE: SWITCH A7 SHOULD BE OFF IF USING WIFI. SINCE WIFI DOESN'T SUPPORT SIMPLIFIED MENUS.

WIFI TRANSCEIVER J34 OR J35

NOTE: SWITCH A7 MUST BE OFF WHEN USING GRAPHIC PANELS (TP800, TP900, OR SPATOUCH FAMILY).

OPTIONAL 120VAC CONFIG FOR SETUPS 3 & 4 ONLY

J24 JUMPERS MUST BE IN 120V POSITIONS AS SHOWN HERE WHEN HEATER IS CONFIGURED AS 120VAC.

F3 FUSE MUST BE REPLACED BY A 0.16A SLO-BLOW FUSE (SUPPLIED WITH PACK) WHEN HEATER IS CONFIGURED AS 120VAC. SAVE THE ORIGINAL 0.1A FUSE IN CASE THE HOMEOWNER WANTS TO CONVERT BACK TO A 240VAC HEATER.

WITH GFCI CORD. SERVICE IS 12A MAX.

16A SERVICE REQUIRES WALL-MOUNT 20A GFCI / BREAKER.

J31 JUMPER MUST BE ON 1 PIN WHEN HEATER IS CONFIGURED AS 120VAC.

WIRING SHOWN IS FOR A 120VAC-ONLY SYSTEM

FOR A 240V HEATER, MAKE THE FOLLOWING CHANGES:

- TB1 MUST BE WIRED WHT-1, BLK-2, RED-3
- MOVE J46 AND J38 WIRES FROM AREA 3 TO AREA 1
- MOVE J24 JUMPER TO THE 240V POSITION
- CHANGE F3 FUSE BACK TO 0.1A SLO-BLOW
- PUT J31 JUMPER ON 2 PINS

F3 FUSE MUST BE RESTORED TO THE 0.1A SLO-BLOW FUSE WHEN HEATER IS CONFIGURED AS 240VAC.

J24 JUMPER MUST BE IN 240V POSITION AS SHOWN HERE WHEN HEATER IS CONFIGURED AS 240VAC.

J31 JUMPER MUST BE ON 2 PINS WHEN HEATER IS CONFIGURED AS 240VAC.

PUMP 1, OZONE, AND CIRC MUST ALL BE 120V IN THIS CONFIGURATION.

EXPANDER X-B PN 59231-01

LOCATION	DEVICE	VOLTS	AMPS	FROM	TO	FROM	TO
J6	BLOWER	240V	4A	J7	AREA 3	J3	J55

USE COPPER CONDUCTORS ONLY. EMPLOYER UNIQUEMENT DES CONDUCTEURS DE CUIVRE. #6 AWG MIN. WIRE= 90°

CONNECT ONLY TO CIRCUITS PROTECTED BY A CLASS A GFCI. A DISCONNECTING MEANS MUST BE INSTALLED WITHIN SIGHT FROM THE EQUIPMENT AND AT LEAST 5 FEET (1.52 M) FROM THE INSIDE WALLS OF THE POOL, SPA, OR HOT TUB.

ON OFF SWITCHES #2 & #3 SHOULD BE SET TO OFF WHEN SYSTEM IS CONFIGURED AS 120VAC.

TORQUE RANGE FOR TB1: 27-30IN. LBS.

TORQUE RANGE FOR HEATER CONNECTIONS: 30 TO 35 IN. LBS.

5.5 kW HEATER (1.4kW @120V)

# Setup Reference Table

Setup #	Circ Pump	Pump 1	Blower	Temp Scale
1	Programmable Filtration + Polling	1-Speed	1-Speed	°F
2	None	2-Speed	1-Speed	°F
3	Programmable Filtration + Polling	1-Speed	None	°F
4	None	2-Speed	None	°F

**System (and any replacement board) is shipped in Setup 2**

Manufactured under one or more of these patents. U.S. Patents: 5332944, 5361215, 5550753, 5559720, 5,883,459, 6253227, 6282370, 6590188, 6976052, 6965815, 7030343, 7,417,834 b2, Canadian Patent: 2342614, Australian patent: 2373248 other patents both foreign and domestic applied for and pending. © Copyright 2009 Balboa Water Group.



# Changing Software Setups with spaTouch™ Icon-Driven Panels

## Test Menu Access (S1, Switch 1 ON) *Service Technician ONLY.*

**DANGER! HIGH VOLTAGE WILL BE ACCESSIBLE! SERVICE TECHNICIAN ONLY!**

While the system is running, move DIP Switch 1 (on S1 on the Main circuit board) to ON. The system will enter Test Mode. Moving DIP Switch 1 to OFF will exit Test Mode.

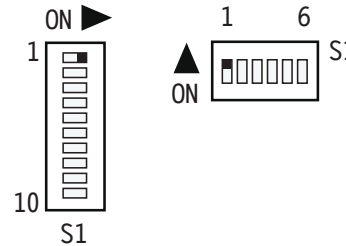

## To Change Software Setups:

While in Test Mode, press the indicated icons to move from screen to screen.

The example screens shown here are from the spaTouch 1 Icon-Driven Panel, but the screens on the spaTouch 2 Panel are similar. The main difference is that the spaTouch 2 display is wider.

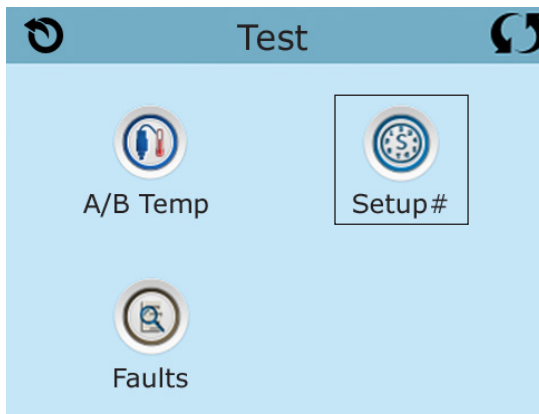
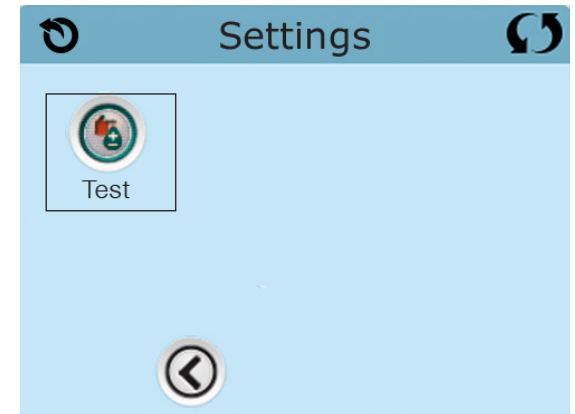
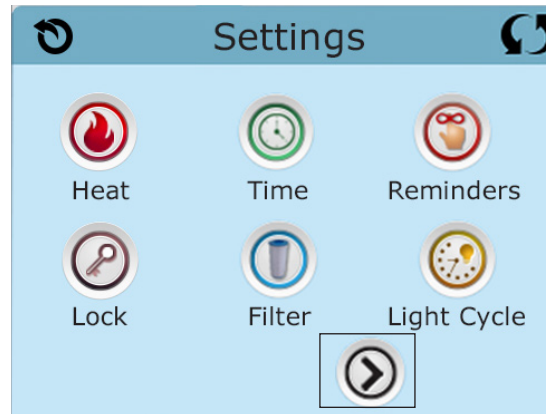
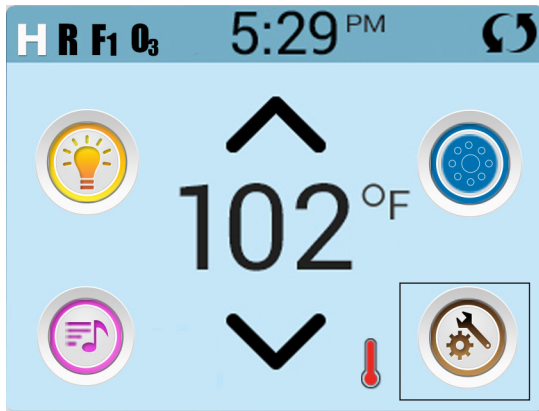

Once on the Setup Selection screen, press the Up or Down icon to select the desired Setup Number, then press the Check Mark icon to confirm and to have the spa restart.

After the system restarts, you may see a message that "The settings have been reset"; this is normal after changing Setups with DIP Switch 6 in the OFF position. Press "Clear" to dismiss this message.

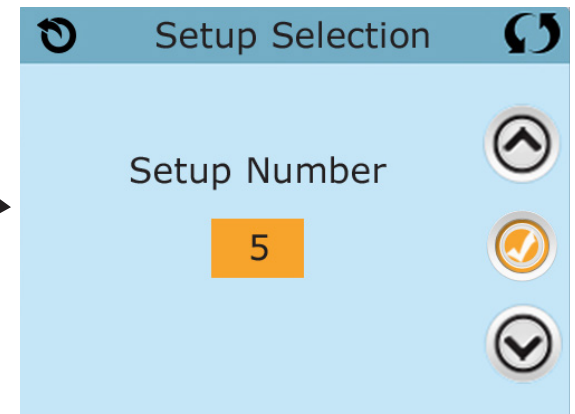

# Changing Software Setups with TP800 / TP900 / spaTouch™ Menued Panel

## Test Menu Access (S1, Switch 1 ON) *Service Technician ONLY.*

**DANGER! HIGH VOLTAGE WILL BE ACCESSIBLE! SERVICE TECHNICIAN ONLY!**

While the system is running, move DIP Switch 1 (on S1 on the Main circuit board) to ON. The system will enter Test Mode. Moving DIP Switch 1 to OFF will exit Test Mode.

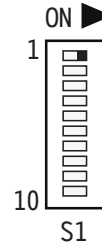

## Software Setups

Under the TEST Menu, the Setup screen will allow changing the Setup from 1 to any number established by the Manufacturer. Changing the Setup may require wiring changes as well.

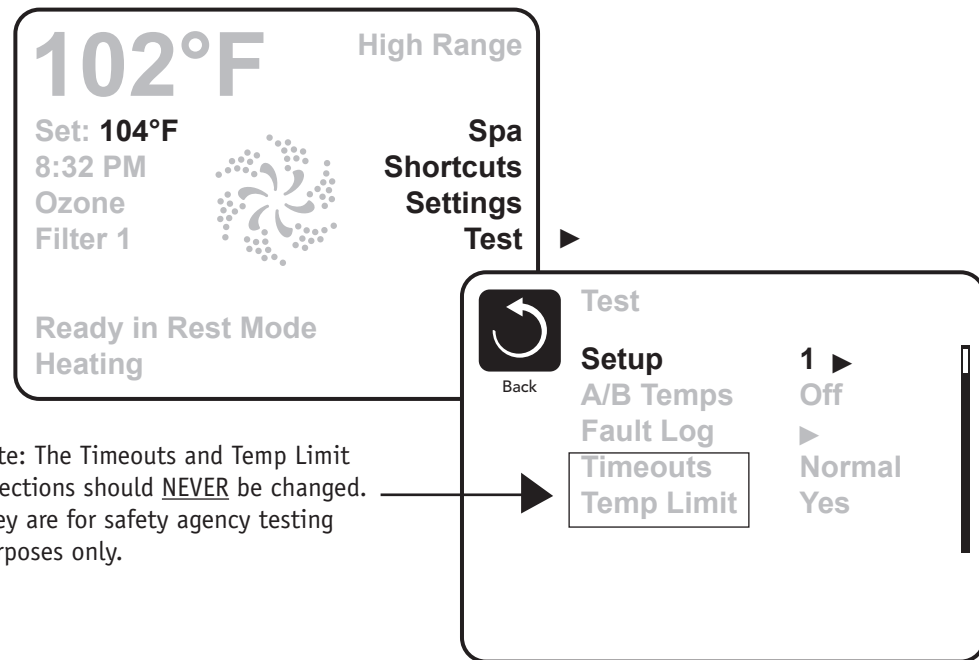

Note: The Timeouts and Temp Limit selections should NEVER be changed. They are for safety agency testing purposes only.



# Changing Software Setups with TP600/TP500/TP400/TP200

## Test Menu Access (S1, Switch 1 ON) *Service Technician ONLY.*

**DANGER! HIGH VOLTAGE WILL BE ACCESSIBLE! SERVICE TECHNICIAN ONLY!**

While the system is running, move DIP Switch 1 (on S1 on the Main circuit board) to ON. The system will enter Test Mode. Moving DIP Switch 1 to OFF will exit Test Mode.

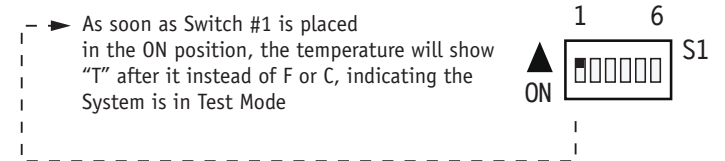

## Software Setups

Under the TEST Menu, the Setup screen will allow changing the Setup from 1 to any number established by the Manufacturer. Changing the Setup may require wiring changes as well.

**You will have 1 minute** to complete the setup change after you manually exit Priming Mode. (Once familiar with the process, the Setup change should take less than 15 seconds.)



When the panel displays RUN PMPS PURG AIR, press any Temperature button ONCE to exit Priming Mode. You should see “---T” where the T indicates the system is in Test Mode.

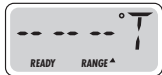

Continued on Next Page.

# Changing Software Setups with TP600/TP500/TP400/TP200 Continued

Again, **You will have 1 minute** to complete the setup change after you manually exit Priming Mode.

NOTE: Wherever the below says Warm or Temp followed by Light, on the TP500 press Menu instead of Warm or Temp followed by light. And whenever the chart below says Light, on the TP500 press Menu instead of Light.

Immediately after exiting Priming Mode, press this sequence of buttons: Warm\*, Light, Warm, Warm, Warm, Warm. Continue to press Warm until the display shows the Setup Number (S-01, S-02, etc.) you want to switch to. When the correct setup number is showing, press Light once, and the system will reset, using the newly-selected Setup from that point on.

Move DIP Switch 1 to the OFF position to take the spa out of Test Mode. °F or °C will replace °T.

**Using a permanent marker, write the Setup number on the Setup label mounted inside the system lid (right). This is very important to any service person in the future who may need to replace a circuit board or system and needs to change the Setup on a replacement part while in the field.**

NOTE: Changing the Setup may require wiring changes as well - refer to the wiring diagram or wiring diagram addendum.

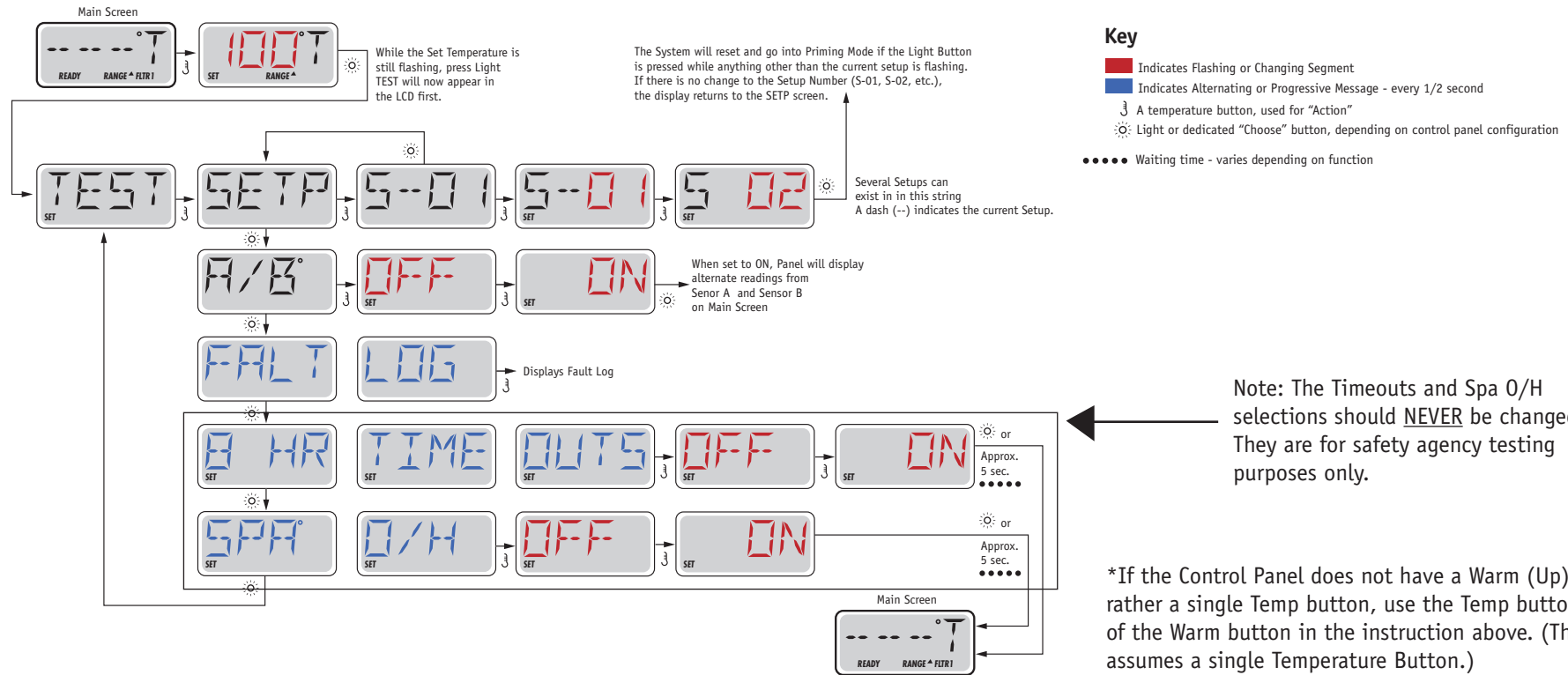
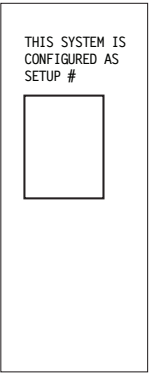

# Equipment Expansion

---

## Expansion Features

### Control Connection

Relay 1 (J5)

### Default

1-Speed Blower

### Fuse

10A

# DIP Switch Functions

## Fixed-function DIP Switches

- A1 Test Mode (normally Off).
- A2 In "ON" position, add one high-speed pump (or blower) with Heater.
- A3 In "ON" position, add two high-speed pumps (or 1 HS Pump and Blower) with Heater.
- A5 In "ON" position, enables Special Amperage Rule B. See Special Features section under Configuration Options for functionality with your system.  
In "OFF" position, enables Special Amperage Rule A.
- A6 Persistent memory reset (Used when the spa is powering up to restore factory settings as determined by software configuration).



**A2 and A3** work in combination to determine the number of high-speed devices and blowers that can run before the heater is disabled. i.e. A2 and A3 in the ON position will allow the heater to operate with up to 3 high-speed pumps (or two HS Pumps and Blower) running at the same time. Heat is disabled when the fourth high-speed pump or blower is turned on.

**Note:** A2/A3 all off = No heat with any high-speed pump or blower.

## Assignable DIP Switches

- A4 In "ON" position, enables a 5-minute cooldown for some gas heaters (Cooling Time B).  
In "OFF" position, enables a 1-minute cooldown for electric heaters (Cooling Time A).
- A7 In "ON" position, Simplified Menus on TP400/TP500/TP600. Do not use graphic panels (TP800, TP900, or spaTouch™ family) with Simplified Menus.  
In "OFF" position, Regular Menus on TP400/TP500/TP600. This setting is compatible with all panels.

*Undesignated switches are not assigned a function.*

# Jumper Definitions

**J109** GFCI Test/Trip Enable/Disable J109   
**Note:** *This feature must be enabled in software as well.*

**J30** Do Not Use

**J31** Jumper on 1 pin when heater voltage is 120V J31   
 Jumper on 2 pins when heater voltage is 240V

**J24** Jumper on center two pins (240V) when heater voltage is 240V. 240V  
J24  120V 120V  
 Two Jumpers installed; one on left 2 pins and one on right 2 pins (120V) when heater voltage is 120V.

## Warning!

Setting DIP switches or jumpers incorrectly may cause abnormal system behavior and/or damage to system components.  
 Refer to Switchbank illustration on Wiring Configuration page for correct settings for this system.  
 Contact Balboa if you require additional configuration pages added to this tech sheet.

Manufactured under one or more of these patents. U.S. Patents: 5332944, 5361215, 5550753, 5559720, 5,883,459, 6253227, 6282370, 6590188, 6976052, 6965815, 7030343, 7,417,834 b2, Canadian Patent: 2342614, Australian patent: 2373248 other patents both foreign and domestic applied for and pending. © Copyright 2009 Balboa Water Group.



# Replacement Parts

---

## PCBA:

Main PCBA: 59496  
Expander PCBA: 59231-01

## HEATER(s):

Heater: 58421R16 5.5kW 800Inc  
58426R16 4.0kW 800Inc  
Temp Sensor Kit: 30344KIT 12-inch sensor  
30382KIT 24-inch sensor

## FUSES:

Part Number	Amperage*	Location
30136	30A	F6
26983	1A	F4, F5 on main board
24514	0.1A	F3 when using 240V heater
26982	0.16A	F3 when using 120V heater
30122	10A	F5 on X-B expander

\* The amperages shown above are only intended for identifying fuses on our boards. They are not complete descriptions of those fuses. Please use the part numbers at the left to order fuses directly from Balboa.

# BP100 Configuration Options

---

## General Features

Feature	Default	
Pump 1 in Filter Cycle (Circ Only)	No	
Pump 1 Low Timer	30 Minutes	Applies in non-circ Setups (configurations) only
General Pump Timer	15 Minutes	
Blower Timer	15 Minutes	
Mister Timer	15 Minutes	
Light Timer	240 Minutes	
Circ (when enabled)	Programmable + Polling	
Cleanup Cycle	<i>30 Minutes</i>	
Cleanup as Preference setting	<i>Yes</i>	
Ozone	With Heater Pump*	
Ozone Suppression	OFF	
Pump Purge	60 Seconds	
Blower Purge	30 Seconds	
Mister Purge	5 Seconds	
Purge Type	Serial - Pumps at lowest speed	

\* The heater Pump can be either a Circ Pump or Pump 1 Low.

# BP100 Configuration Options

## Temperature Features

Feature	Default
Temperature Display	°F

All temperatures must be specified in °F. The system converts °F to °C dynamically. If Celsius is required for default settings, choose a desired °C value that (after rounding) corresponds to a Fahrenheit value.

°C	4	5	6	7	8	9	10	11	12	13	14	15	16	17	18	19	20	21	22
°F	39	41	43	45	46	48	50	52	54	55	57	59	61	63	64	66	68	70	72
°C	23	24	25	26	27	28	29	30	31	32	33	34	35	36	37	38	39	40	
°F	73	75	77	79	81	82	84	86	88	90	91	93	95	97	99	100	102	104	

Hi-Range Min. Set Temp	80°F
Hi-Range Max. Set Temp	104°F
Hi-Range Default Temp*	100°F
Lo-Range Min. Set Temp	50°F
Lo-Range Max. Set Temp	99°F
Lo-Range Default Temp*	70°F
Freeze Threshold	44°F
Freeze Type	Rotating - Pumps at Lowest Speed
Temp Lock Type	Temp + Settings

*\*May be changed by end-user (if enabled)*

Manufactured under one or more of these patents. U.S. Patents: 5332944, 5361215, 5550753, 5559720, 5,883,459, 6253227, 6282370, 6590188, 6976052, 6965815, 7030343, 7,417,834 b2, Canadian Patent: 2342614, Australian patent: 2373248 other patents both foreign and domestic applied for and pending. © Copyright 2009 Balboa Water Group.



# BP100 Configuration Options

---

## Time Features

<b>Feature</b>	<b>Default</b>
Time Format*	12 Hour
Filter 1 Start Hour*	20:00 (8:00 PM)
Filter 1 Duration*	2 Hours
Filter Cycle 2 Default*	OFF
Filter 2 Start Hour*	08:00 (8:00 AM)
Filter 2 Duration*	15 Minutes
Light Cycle	Disabled
Light Cycle Default*	OFF
Light Cycle Start Hour*	21:00 (9:00 PM)
Light Cycle Duration*	15 Minutes
Cooling Time A	1 Minute
Cooling Time B	5 Minutes

*\*May be changed by end-user (if enabled)*

Manufactured under one or more of these patents. U.S. Patents: 5332944, 5361215, 5550753, 5559720, 5,883,459, 6253227, 6282370, 6590188, 6976052, 6965815, 7030343, 7,417,834 b2, Canadian Patent: 2342614, Australian patent: 2373248 other patents both foreign and domestic applied for and pending. © Copyright 2009 Balboa Water Group.

# BP100 Configuration Options

---

## Reminder Features

Feature	Default
Reminders Shown*	<i>Yes</i>
Check pH	<i>OFF</i>
Check Sanitizer	<i>OFF</i>
Clean Filter	30 Days
Test GFCI	OFF
Drain Water	<i>100 Days</i>
Change Cartridge	OFF
Clean Cover	<i>OFF</i>
Treat Wood	<i>OFF</i>
Change Filter	365 Days

*\*May be changed by end-user (if enabled)*

Manufactured under one or more of these patents. U.S. Patents: 5332944, 5361215, 5550753, 5559720, 5,883,459, 6253227, 6282370, 6590188, 6976052, 6965815, 7030343, 7,417,834 b2, Canadian Patent: 2342614, Australian patent: 2373248 other patents both foreign and domestic applied for and pending. © Copyright 2009 Balboa Water Group.

# BP100 Configuration Options

---

## Special Features

Feature	Default
Special Amperage Rule A	No Limitation
Special Amperage Rule B	No Limitation
Drain Mode	Disabled
Demo Mode	Disabled
GFCI Trip	Enabled
Automatic GFCI Test	Disabled
Ozone Slaved to Heater Pump	Yes
Dual Voltage Heater	Always Input Voltage
Safety Suction	Disabled
Menu Style	Standard Menus when DIP switch A7 is OFF. Simplified Menus when DIP switch A7 is ON..

# TP900 Panel Configuration

## Button Layout Table

Button #	Setup 1	Setup 2	Setup 3	Setup 4
1	N/A	N/A	N/A	N/A
2	Jets 1	Jets 1	Jets 1	Jets 1
3	Blower	Blower	Light	Light
4	Light	Light	Invert	Invert
5	Invert	Invert	(Circ Icon)	Undefined
6	(Circ Icon)	Undefined	Undefined	Undefined
7	Undefined	Undefined	Undefined	Undefined
8	Undefined	Undefined	Undefined	Undefined
9	Undefined	Undefined	Undefined	Undefined
10	Undefined	Undefined	Undefined	Undefined
11	N/A	N/A	N/A	N/A
12	N/A	N/A	N/A	N/A
13	Jets 1	Jets 1	Jets 1	Jets 1
14	Blower	Blower	Undefined	Undefined
15	Light	Light	Light	Light
16	Invert	Invert	Invert	Invert

### Spa Screen

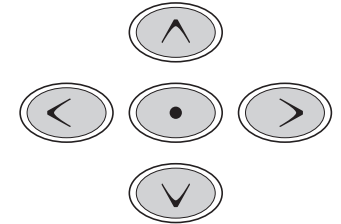
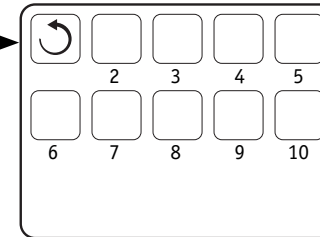

### Shortcuts Screen

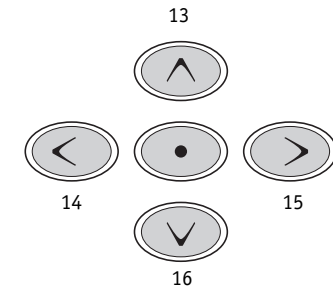
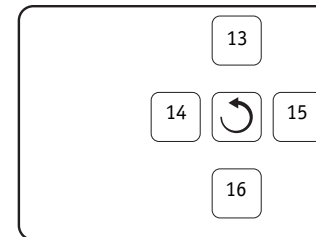

*A Circ Icon will appear when a Circ Pump is configured*

# TP800 Panel Configuration

**Button Layout Table**

Feature #	Setup 1	Setup 2	Setup 3	Setup 4
A1	N/A	N/A	N/A	N/A
A2	Jets 1	Jets 1	Jets 1	Jets 1
A3	Blower	Blower	Light 1	Light 1
A4	Light 1	Light 1	Invert	Invert
A5	Invert	Invert	(Circ Icon)	Undefined
A6	(Circ Icon)	Undefined	Undefined	Undefined
A7	Undefined	Undefined	Undefined	Undefined
A8	Undefined	Undefined	Undefined	Undefined
A9	Undefined	Undefined	Undefined	Undefined
A10	Undefined	Undefined	Undefined	Undefined
A11	N/A	N/A	N/A	N/A
A12	N/A	N/A	N/A	N/A
A13	Undefined	Undefined	Undefined	Undefined
A14	Undefined	Undefined	Undefined	Undefined
A15	Undefined	Undefined	Undefined	Undefined
A16	Undefined	Undefined	Undefined	Undefined
B1	Jets 1	Jets 1	Jets 1	Jets 1
B2	Blower	Blower	Undefined	Undefined
B3	Undefined	Undefined	Undefined	Undefined
B4	Light 1	Light 1	Light 1	Light 1

# TP800 Panel Configuration

## Spa Screen

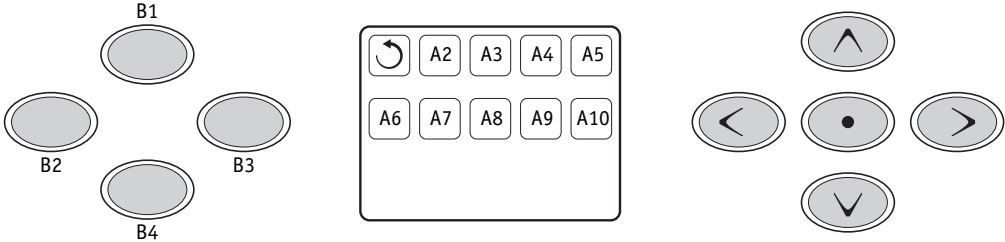

## Shortcuts Screen

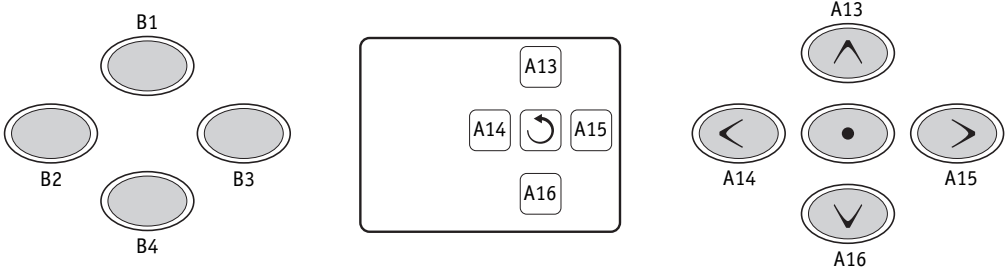

**Note:** Buttons 11 and 12 are not used in this configuration.  
Button 1 is fixed.

# TP600 Panel Configuration

**Button Layout Table**

Button #	Setups 1 & 2	Setups 3 & 4
1	Jets 1	Jets 1
2	Blower	Undefined
3	Invert	Invert
4	Up	Up
5	Light 1	Light 1
6	Down	Down
<b>LED 1</b>	Jets 1	Jets 1
<b>LED 2</b>	Blower	Undefined
<b>LED 3</b>	Light 1	Light 1
<b>LED 4</b>	Heat On	Heat On

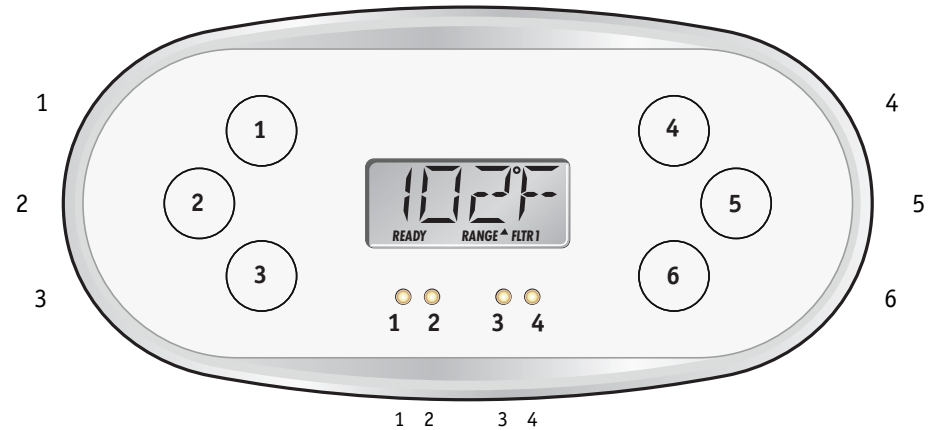

## TP600

55676-XX

No Overlay

# TP400/TP200 Panel Configuration

## Button Layout Table for TP400T/TP200T

Button #	Setups 1 & 2	Setups 3 & 4
1	Temperature	Temperature
2	Jets 1	Jets 1
3	Light 1	Light 1
4	Blower	Undefined
LED 1	Heater ON	Heater ON
LED 2	Jets 1 ON	Jets 1 ON
LED 3	Light ON	Light ON
LED 4	Blower	Undefined

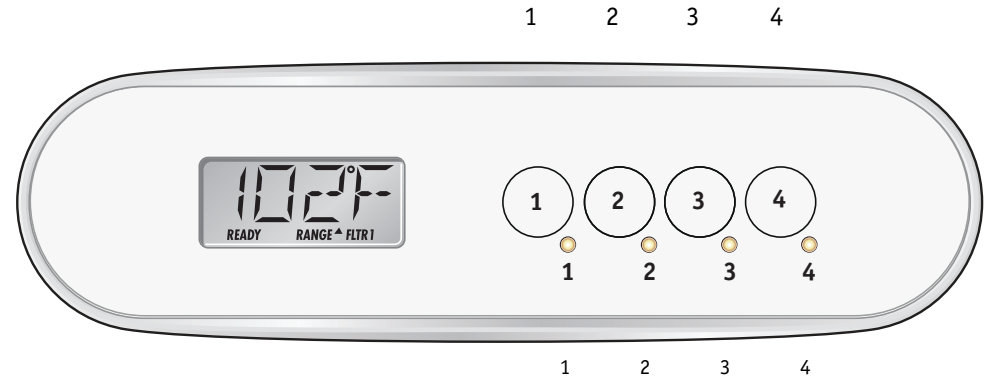

### TP400T US

50380-XX includes overlay PN 12511

## Button Layout Table for TP400W/TP200W

Button #	All Setups
1	Up
2	Down
3	Light 1
4	Jets 1
LED 1	Heater ON
LED 2	Undefined
LED 3	Light ON
LED 4	Jets 1 ON

TP400W/TP200W is supported in Setups 3 & 4 only



### TP200T

57281-XX with no overlay

57282-XX includes overlay PN 17325

### TP400W US

50384-XX includes overlay PN 12510

### TP200W

57290-XX with no overlay

57283-XX includes overlay PN 17374